

User's Manual  
**Model 335**  
Temperature Controller



Lake Shore Cryotronics, Inc.  
575 McCorkle Blvd.  
Westerville, Ohio 43082-8888 USA

sales@lakeshore.com  
service@lakeshore.com  
www.lakeshore.com

Fax: (614) 891-1392  
Telephone: (614) 891-2243

Methods and apparatus disclosed and described herein have been developed solely on company funds of Lake Shore Cryotronics, Inc. No government or other contractual support or relationship whatsoever has existed which in any way affects or mitigates proprietary rights of Lake Shore Cryotronics, Inc. in these developments. Methods and apparatus disclosed herein may be subject to U.S. Patents existing or applied for.

Lake Shore Cryotronics, Inc. reserves the right to add, improve, modify, or withdraw functions, design modifications, or products at any time without notice. Lake Shore shall not be liable for errors contained herein or for incidental or consequential damages in connection with furnishing, performance, or use of this material.

## LIMITED WARRANTY STATEMENT

### WARRANTY PERIOD: THREE (3) YEARS

1. Lake Shore warrants that products manufactured by Lake Shore (the "Product") will be free from defects in materials and workmanship for three years from the date of Purchaser's physical receipt of the Product (the "Warranty Period"). If Lake Shore receives notice of any such defects during the Warranty Period and the defective Product is shipped freight prepaid back to Lake Shore, Lake Shore will, at its option, either repair or replace the Product (if it is so defective) without charge for parts, service labor or associated customary return shipping cost to the Purchaser. Replacement for the Product may be by either new or equivalent in performance to new. Replacement or repaired parts, or a replaced Product, will be warranted for only the unexpired portion of the original warranty or 90 days (whichever is greater).

2. Lake Shore warrants the Product only if the Product has been sold by an authorized Lake Shore employee, sales representative, dealer or an authorized Lake Shore original equipment manufacturer (OEM).

3. The Product may contain remanufactured parts equivalent to new in performance or may have been subject to incidental use when it is originally sold to the Purchaser.

4. The Warranty Period begins on the date of Purchaser's physical receipt of the Product or later on the date of operational training and verification (OT&V) of the Product if the service is performed by Lake Shore, provided that if the Purchaser schedules or delays the Lake Shore OT&V for more than 30 days after delivery then the Warranty Period begins on the 31st day after Purchaser's physical receipt of the Product.

5. This limited warranty does not apply to defects in the Product resulting from (a) improper or inadequate installation (unless OT&V services are performed by Lake Shore), maintenance, repair or calibration, (b) fuses, software, power surges, lightning and non-rechargeable batteries, (c) software, interfacing, parts or other supplies not furnished by Lake Shore, (d) unauthorized modification or misuse, (e) operation outside of the published specifications, (f) improper site preparation or site maintenance (g) natural disasters such as flood, fire, wind, or earthquake, or (h) damage during shipment other than original shipment to you if shipped through a Lake Shore carrier.

6. This limited warranty does not cover: (a) regularly scheduled or ordinary and expected recalibrations of the Product; (b) accessories to the Product (such as probe tips and cables, holders, wire, grease, varnish, feed throughs, etc.); (c) consumables used in conjunction with the Product (such as probe tips and cables, probe holders, sample tails, rods and holders, ceramic putty for mounting samples, Hall sample cards, Hall sample enclosures, etc.); or, (d) non-Lake Shore branded Products that are integrated with the Product.

7. To the extent allowed by applicable law, this limited warranty is the only warranty applicable to the Product and replaces all other warranties or conditions, express or implied, including, but not limited to, the implied warranties or conditions of merchantability and fitness for a particular purpose. Specifically, except as provided herein,

Lake Shore undertakes no responsibility that the products will be fit for any particular purpose for which you may be buying the Products. Any implied warranty is limited in duration to the warranty period. No oral or written information, or advice given by the Company, its Agents or Employees, shall create a warranty or in any way increase the scope of this limited warranty. Some countries, states or provinces do not allow limitations on an implied warranty, so the above limitation or exclusion might not apply to you. This warranty gives you specific legal rights and you might also have other rights that vary from country to country, state to state or province to province.

8. Further, with regard to the United Nations Convention for International Sale of Goods (CISG) if CISG is found to apply in relation to this agreement, which is specifically disclaimed by Lake Shore, then this limited warranty excludes warranties that: (a) the Product is fit for the purpose for which goods of the same description would ordinarily be used, (b) the Product is fit for any particular purpose expressly or impliedly made known to Lake Shore at the time of the conclusion of the contract. (c) the Product is contained or packaged in a manner usual for such goods or in a manner adequate to preserve and protect such goods where it is shipped by someone other than a carrier hired by Lake Shore.

9. Lake Shore disclaims any warranties of technological value or of non-infringement with respect to the Product and Lake Shore shall have no duty to defend, indemnify, or hold harmless you from and against any or all damages or costs incurred by you arising from the infringement of patents or trademarks or violation or copyrights by the Product.

10. THIS WARRANTY IS NOT TRANSFERRABLE. This warranty is not transferrable.

11. Except to the extent prohibited by applicable law, neither Lake Shore nor any of its subsidiaries, affiliates or suppliers will be held liable for direct, special, incidental, consequential or other damages (including lost profit, lost data, or downtime costs) arising out of the use, inability to use or result of use of the product, whether based in warranty, contract, tort or other legal theory, regardless whether or not Lake Shore has been advised of the possibility of such damages. Purchaser's use of the Product is entirely at Purchaser's risk. Some countries, states and provinces do not allow the exclusion of liability for incidental or consequential damages, so the above limitation may not apply to you.

12. This limited warranty gives you specific legal rights, and you may also have other rights that vary within or between jurisdictions where the product is purchased and/or used. Some jurisdictions do not allow limitation in certain warranties, and so the above limitations or exclusions of some warranties stated above may not apply to you.

13. Except to the extent allowed by applicable law, the terms of this limited warranty statement do not exclude, restrict or modify the mandatory statutory rights applicable to the sale of the product to you.

## **CERTIFICATION**

Lake Shore certifies that this product has been inspected and tested in accordance with its published specifications and that this product met its published specifications at the time of shipment. The accuracy and calibration of this product at the time of shipment are traceable to the United States National Institute of Standards and Technology (NIST); formerly known as the National Bureau of Standards (NBS).

## **FIRMWARE LIMITATIONS**

Lake Shore has worked to ensure that the Model 335 firmware is as free of errors as possible, and that the results you obtain from the instrument are accurate and reliable. However, as with any computer-based software, the possibility of errors exists.

In any important research, as when using any laboratory equipment, results should be carefully examined and rechecked before final conclusions are drawn. Neither Lake Shore nor anyone else involved in the creation or production of this firmware can pay for loss of time, inconvenience, loss of use of the product, or property damage caused by this product or its failure to work, or any other incidental or consequential damages. Use of our product implies that you understand the Lake Shore license agreement and statement of limited warranty.

## **FIRMWARE LICENSE AGREEMENT**

The firmware in this instrument is protected by United States copyright law and international treaty provisions. To maintain the warranty, the code contained in the firmware must not be modified. Any changes made to the code is at the user's risk. Lake Shore will assume no responsibility for damage or errors incurred as result of any changes made to the firmware.

## **FIRMWARE LICENSE AGREEMENT (continued)**

Under the terms of this agreement you may only use the Model 335 firmware as physically installed in the instrument. Archival copies are strictly forbidden. You may not decompile, disassemble, or reverse engineer the firmware. If you suspect there are problems with the firmware, return the instrument to Lake Shore for repair under the terms of the Limited Warranty specified above. Any unauthorized duplication or use of the Model 335 firmware in whole or in part, in print, or in any other storage and retrieval system is forbidden.

## **TRADEMARK ACKNOWLEDGMENT**

Many manufacturers and sellers claim designations used to distinguish their products as trademarks. Where those designations appear in this manual and Lake Shore was aware of a trademark claim, they appear with initial capital letters and the <sup>TM</sup> or <sup>®</sup> symbol. Alumel<sup>TM</sup> and Chromel<sup>TM</sup> are trademarks of Conceptech, Inc., Corporation  
Apiezon<sup>TM</sup> is a registered trademark of M&I Materials, Ltd.  
CalCurve<sup>TM</sup>, Cernox<sup>TM</sup>, SoftCal<sup>TM</sup>, Rox<sup>TM</sup>, Curve Handler<sup>TM</sup> are trademarks of Lake Shore Cryotronics, Inc.  
Java<sup>TM</sup> is a registered trademark of Sun Microsystems, Inc. of Santa Clara, CA  
LabVIEW<sup>®</sup> is a registered trademark of National Instruments.  
Mac<sup>®</sup> is a registered trademark of Apple, Inc., registered in the U.S and other countries.  
Microsoft Windows<sup>®</sup>, Excel<sup>®</sup>, and Windows Vista<sup>®</sup> are registered trademarks of Microsoft Corporation in the United States and other countries.  
Stycast<sup>®</sup> is a trademark of Emerson & Cuming.  
WinZip<sup>TM</sup> is a registered trademark of Nico Mak of Connecticut.

Copyright 2011 - 2012 Lake Shore Cryotronics, Inc. All rights reserved. No portion of this manual may be reproduced, stored in a retrieval system, or transmitted, in any form or by any means, electronic, mechanical, photocopying, recording, or otherwise, without the express written permission of Lake Shore.



## DECLARATION OF CONFORMITY

We: Lake Shore Cryotronics, Inc.  
575 McCorkle Blvd.  
Westerville, OH 43082 USA

hereby declare that the equipment specified conforms to the following Directives and Standards:

Application of Council Directives .....73/23/EEC  
89/336/EEC

Standards to which Conformity is declared ..... EN-61010-1:2006  
Overvoltage II  
Pollution Degree 2  
EN 61326-1:2006  
Class A  
Annex B

Model Number .....335

 3/29/2011

**Edward Maloof**  
*Printed name*

**Vice President of Engineering**  
*Position*



**DECLARATION OF CONFORMITY**  
in relation to  
**DIRECTIVE 2002/95/EC OF THE EUROPEAN PARLIAMENT  
AND OF THE COUNCIL  
OF 27 JANUARY 2003  
ON THE RESTRICTION OF THE  
USE OF CERTAIN HAZARDOUS SUBSTANCES (RoHS) IN  
ELECTRICAL AND ELECTRONIC EQUIPMENT**

The Lake Shore Model 335 temperature controller complies fully with the requirements of Directive 2002/95/EC on the Restriction of the use of certain Hazardous Substances (RoHS). In accordance with Article 4.1 of Directive 2002/95/EC, restricted substances are not present above the tolerated values defined within Commission Decision 2005/618/EC.

*Edward Maloof* 3/29/2011

**Edward Maloof**  
*Printed name*

**Vice President of Engineering**  
*Position*



Lake Shore Cryotronics, Inc. • 575 McCorkle Boulevard • Westerville, OH 43082  
Sales: (614) 891-2244 • Fax: (614) 891-1392 • sales@lakeshore.com • www.lakeshore.com

Note: The Model 335 is considered Waste Electrical and Electronic Equipment (WEEE) Category 9 equipment, therefore falling outside the current scope of the RoHS directive. However, in recognition that RoHS compliance is in the best interest of our customers, employees, and the environment, Lake Shore has designed the Model 335 to eliminate the hazardous substances covered in the RoHS directive.

## Electromagnetic Compatibility (EMC) for the Model 335 Temperature Controller

Electromagnetic Compatibility (EMC) of electronic equipment is a growing concern worldwide. Emissions of and immunity to electromagnetic interference is now part of the design and manufacture of most electronics. To qualify for the CE Mark, the Model 335 meets or exceeds the requirements of the European EMC Directive 89/335/EEC as a CLASS A product. A Class A product is allowed to radiate more RF than a Class B product and must include the following warning:

**WARNING:** This is a Class A product. In a domestic environment, this product may cause radio interference in which case the user may be required to take adequate measures.

The instrument was tested under normal operating conditions with sensor and interface cables attached. If the installation and operating instructions in the User's Manual are followed, there should be no degradation in EMC performance.

This instrument is not intended for use in close proximity to RF transmitters such as two-way radios and cell phones. Exposure to RF interference greater than that found in a typical laboratory environment may disturb the sensitive measurement circuitry of the instrument.

Pay special attention to instrument cabling. Improperly installed cabling may defeat even the best EMC protection. For the best performance from any precision instrument, follow the grounding and shielding instructions in the User's Manual. In addition, the installer of the Model 335 should consider the following:

- Shield measurement and computer interface cables.
- Leave no unused or unterminated cables attached to the instrument.
- Make cable runs as short and direct as possible. Higher radiated emissions are possible with long cables.
- Do not tightly bundle cables that carry different types of signals.

# Table of Contents

## Chapter 1 Introduction

1.1	Product Description .....	1
1.1.1	Sensor Inputs .....	2
1.1.2	Temperature Control .....	3
1.1.3	Interface .....	3
1.1.4	Configurable Display .....	4
1.1.5	Model 3060 Thermocouple Input Option .....	4
1.2	Sensor Selection .....	5
1.3	Model 335 Specifications .....	7
1.3.1	Input Specifications .....	7
1.3.2	Sensor Input Configuration .....	8
1.3.3	Thermometry .....	8
1.3.4	Control .....	8
1.3.4.1	Heater Outputs (Outputs 1 and 2) .....	8
1.3.5	Front Panel .....	10
1.3.6	Interface .....	10
1.3.7	General .....	10
1.4	Safety Summary and Symbols .....	11

## Chapter 2 Cooling System Design and Temperature Control

2.1	General .....	13
2.2	Temperature Sensor Selection .....	13
2.2.1	Temperature Range .....	13
2.2.2	Sensor Sensitivity .....	13
2.2.3	Environmental Conditions .....	14
2.2.4	Measurement Accuracy .....	14
2.2.5	Sensor Package .....	14
2.3	Sensor Calibrations .....	14
2.3.1	Precision Calibration .....	15
2.3.2	SoftCal™ .....	15
2.3.3	Sensors Using Standard Curves .....	15
2.3.4	Curve Handler™ .....	15
2.4	Sensor Installation .....	16
2.4.1	Mounting Materials .....	16
2.4.2	Sensor Location .....	16
2.4.3	Thermal Conductivity .....	16
2.4.4	Contact Area .....	17
2.4.5	Contact Pressure .....	17
2.4.6	Lead Wire .....	17
2.4.7	Lead Soldering .....	18
2.4.8	Thermal Anchoring Leads .....	18
2.4.9	Thermal Radiation .....	19
2.5	Heater Selection and Installation .....	19
2.5.1	Heater Resistance and Power .....	19
2.5.2	Heater Location .....	20
2.5.3	Heater Types .....	20
2.5.4	Heater Wiring .....	21
2.6	Consideration for Good Control .....	21
2.6.1	Thermal Conductivity .....	21
2.6.2	Thermal Lag .....	21
2.6.3	Two-Sensor Approach .....	21
2.6.4	Thermal Mass .....	22
2.6.5	System Non-Linearity .....	22

2.7	PID Control .....	22
2.7.1	Proportional (P) .....	23
2.7.2	Integral (I) .....	23
2.7.3	Derivative (D).....	23
2.7.4	Manual Output .....	23
2.8	Manual Tuning .....	25
2.8.1	Setting Heater Range .....	25
2.8.2	Tuning Proportional .....	25
2.8.3	Tuning Integral .....	26
2.8.4	Tuning Derivative .....	27
2.9	Autotuning .....	27
2.10	Zone Tuning .....	28
2.11	Thermoelectric Devices .....	28

## Chapter 3 Installation

3.1	General .....	29
3.2	Inspection and Unpacking .....	29
3.3	Rear Panel Definition .....	30
3.4	Line Input Assembly .....	30
3.4.1	Line Voltage .....	30
3.4.2	Line Fuse and Fuse Holder .....	31
3.4.3	Power Cord .....	31
3.4.4	Power Switch .....	31
3.5	Diode/Resistor Sensor Inputs .....	31
3.5.1	Sensor Input Connector and Pinout .....	31
3.5.2	Sensor Lead Cable .....	32
3.5.3	Grounding and Shielding Sensor Leads .....	32
3.5.4	Sensor Polarity .....	33
3.5.5	Four-Lead Sensor Measurement .....	33
3.5.6	Two-Lead Sensor Measurement .....	34
3.5.7	Lowering Measurement Noise .....	34
3.6	Thermocouple Sensor Inputs (Thermocouple Model 3060) .....	35
3.6.1	Sensor Input Terminals .....	35
3.6.2	Thermocouple Installation .....	35
3.6.3	Grounding and Shielding .....	35
3.7	Heater Output Setup .....	36
3.7.1	Heater Output Description .....	36
3.7.2	Heater Output Connectors .....	36
3.7.3	Heater Output Wiring .....	36
3.7.4	Heater Output Noise .....	37
3.7.5	Powering Output 2 Using an External Power Supply .....	37
3.7.5.1	Choosing a Power Supply .....	37
3.7.5.2	Power Supply Setup .....	38
3.7.5.3	Connecting to the Model 335 .....	38
3.7.5.4	Programming Voltages Under 10 V .....	39

## Chapter 4 Operation

4.1	General .....	41
4.1.1	Understanding Menu Navigation .....	41
4.2	Front Panel Description .....	42
4.2.1	Keypad Definitions .....	42
4.2.1.1	Direct Operation Keys .....	42
4.2.1.2	Menu/Number Pad Keys .....	42
4.2.2	Annunciators .....	43
4.2.3	General Keypad Operation .....	43

4.3	Display Setup	44
4.3.1	Display Modes	44
4.3.1.1	Two Input, One Loop Modes	44
4.3.1.2	Two Loop Mode	45
4.3.1.3	Input Display Modes	45
4.3.1.4	Custom Display Mode	46
4.3.2	Display Brightness	47
4.4	Input Setup	47
4.4.1	Diode Sensor Input Setup	48
4.4.2	Positive Temperature Coefficient (PTC) Resistor Sensor Input Setup	48
4.4.3	Negative Temperature Coefficient (NTC) Resistor Sensor Input Setup	48
4.4.4	Range Selection	49
4.4.5	Thermal Electromotive Force (EMF) Compensation	49
4.4.6	Thermocouple Sensor Input Setup (Model 3060 Only)	50
4.4.6.1	Internal Room Temperature Compensation	50
4.4.6.2	Internal Room Temperature Compensation Calibration Procedure	50
4.4.7	Curve Selection	51
4.4.8	Filter	52
4.4.9	Input Name	53
4.4.10	Temperature Limit	53
4.4.11	Preferred Units	54
4.4.12	Max/Min	54
4.5	Output and Control Setup	54
4.5.1	Heater Outputs	54
4.5.1.1	Heater Output Type (Output 2)	55
4.5.1.2	75 W Configuration	55
4.5.1.3	Max Current and Heater Resistance	55
4.5.1.3.1	User Max Current	56
4.5.1.4	Power Up Enable	57
4.5.1.5	Heater Out Display	58
4.5.1.6	Output Modes	58
4.5.1.6.1	Closed Loop PID Mode	58
4.5.1.6.2	Zone Mode	58
4.5.1.6.3	Open Loop Mode	59
4.5.1.7	Control Parameters	59
4.5.1.7.1	Control Input	59
4.5.1.7.2	Proportional (P)	60
4.5.1.7.3	Integral (I)	60
4.5.1.7.4	Derivative (D)	61
4.5.1.7.5	Manual Output	61
4.5.1.7.6	Setpoint	62
4.5.1.7.7	Setpoint Ramping	63
4.5.1.7.8	Heater Range	64
4.5.1.7.9	ALL OFF	64
4.5.2	Voltage Output	64
4.5.2.1	Warm Up Supply	65
4.5.2.2	Monitor Out	65
4.6	Interface	65
4.6.1	USB	65
4.6.2	IEEE-488	65
4.6.2.1	Remote/Local	65
4.7	Locking and Unlocking the Keypad	65

## Chapter 5 Advanced Operation

5.1	General	67
5.2	Autotune	67
5.3	Zone Settings	69
5.4	Bipolar Control	71
5.5	Warm Up Supply	71
5.5.1	Warm Up Percentage	72
5.5.2	Warm Up Control	72
5.6	Monitor Out	72
5.6.1	Monitor Units	73
5.6.1.1	Polarity and Monitor Out Scaling Parameters	73
5.7	Alarms and Relays	74
5.7.1	Alarms	74
5.7.1.1	Alarm Annunciators	74
5.7.1.2	Alarm Latching	75
5.7.2	Relays	76
5.8	Curve Numbers and Storage	77
5.8.1	Curve Header Parameters	77
5.8.2	Curve Breakpoints	77
5.9	Front Panel Curve Entry Operations	78
5.9.1	Edit Curve	78
5.9.1.1	Edit a Breakpoint Pair	79
5.9.1.2	Add a New Breakpoint Pair	80
5.9.1.3	Delete a Breakpoint Pair	80
5.9.1.4	Thermocouple Curve Considerations	80
5.9.2	Erase Curve	81
5.9.3	Copy Curve	81
5.10	SoftCal™	81
5.10.1	SoftCal™ with Silicon Diode Sensors	82
5.10.2	SoftCal™ Accuracy with DT-400 Series Silicon Diode Sensors	83
5.10.3	SoftCal™ With Platinum Sensors	83
5.10.4	SoftCal™ Accuracy With Platinum Sensors	84
5.10.5	SoftCal™ Calibration Curve Creation	84
5.11	Emulation Modes	85
5.11.1	Emulation Mode Configuration	85
5.11.2	Unsupported Commands	86
5.11.3	Command Interpretation	86
5.11.4	PID Scaling Mode	86
5.11.5	Baud Rate	86
5.11.6	Hardware Differences	87
5.11.7	Emulation Mode Differences	87

## Chapter 6 Computer Interface Operation

6.1	General	89
6.2	IEEE-488 Interface	89
6.2.1	Changing IEEE-488 Interface Parameters	90
6.2.2	Remote/Local Operation	90
6.2.3	IEEE-488.2 Command Structure	90
6.2.3.1	Bus Control Commands	90
6.2.3.2	Common Commands	91
6.2.3.3	Device Specific Commands	91
6.2.3.4	Message Strings	91
6.2.4	Status System Overview	92
6.2.4.1	Condition Registers	92
6.2.4.2	Event Registers	92
6.2.4.3	Enable Registers	92
6.2.4.4	Status Byte Register	94
6.2.4.5	Service Request Enable Register	94
6.2.4.6	Reading Registers	94



6.2.4.7	Programming Registers	94
6.2.4.8	Clearing Registers	95
6.2.5	Status System Detail: Status Register Sets	95
6.2.5.1	Standard Event Status Register Set	95
6.2.5.2	Operation Event Register Set	96
6.2.6	Status System Detail: Status Byte Register and Service Request	97
6.2.6.1	Status Byte Register	97
6.2.6.2	Service Request Enable Register	98
6.2.6.3	Using Service Request (SRQ) and Serial Poll	98
6.2.6.4	Using Status Byte Query (*STB?)	99
6.2.6.5	Using the Message Available (MAV) Bit	99
6.2.6.6	Using Operation Complete (*OPC) and Operation Complete Query (*OPC?)	99
6.3	USB Interface	100
6.3.1	Physical Connection	100
6.3.2	Hardware Support	100
6.3.3	Installing the USB Driver	100
6.3.3.1	Installing the Driver From Windows® Update in Windows Vista® or Windows 7	100
6.3.3.2	Installing the Driver From Windows® Update in Windows® XP	101
6.3.3.3	Installing the Driver From the Web	101
6.3.3.3.1	Download the driver	101
6.3.3.3.2	Extract the driver	101
6.3.3.3.3	Manually install the driver	102
6.3.3.4	Installing the USB Driver from the Included CD	103
6.3.4	Communication	104
6.3.4.1	Character Format	104
6.3.4.2	Message Strings	104
6.3.5	Message Flow Control	104
6.4	Command Summary	105
6.4.1	Interface Commands	107
<b>Chapter 7</b>		
<b>Options and Accessories</b>		
7.1	General	127
7.2	Models	127
7.3	Options	127
7.4	Accessories	127
7.5	Rack Mounting	129
7.6	Model 3060-H Thermocouple Input Option	130
7.7	Model 3003 Heater and Output Conditioner	131
<b>Chapter 8</b>		
<b>Service</b>		
8.1	General	133
8.2	USB Troubleshooting	133
8.2.1	New Installation	133
8.2.2	Existing Installation No Longer Working	133
8.2.3	Intermittent Lockups	133
8.3	IEEE Interface Troubleshooting	134
8.3.1	New Installation	134
8.3.2	Existing Installation No Longer Working	134
8.3.3	Intermittent Lockups	134
8.4	Fuse Drawer	134
8.5	Line Voltage Selection	134
8.6	Fuse Replacement	135
8.7	Factory Reset Menu	136
8.7.1	Default Values	136
8.7.2	Product Information	137
8.8	Error Messages	137
8.9	Calibration Procedure	137

8.10 Rear Panel Connector Definition .....	138
8.10.1 IEEE-488 Interface Connector .....	140
8.11 Electrostatic Discharge .....	141
8.11.1 Identification of Electrostatic Discharge Sensitive Components .....	141
8.11.2 Handling Electrostatic Discharge Sensitive Components .....	141
8.12 Model 3060 Installation .....	141
8.13 Firmware Updates .....	143
8.13.1 Updating the Firmware .....	143
8.14 Technical Inquiries .....	144
8.14.1 Contacting Lake Shore .....	144
8.14.2 Return of Equipment .....	144
8.14.3 RMA Valid Period .....	144
8.14.4 Shipping Charges .....	145
8.14.5 Restocking Fee .....	145

# Chapter 1: Introduction



FIGURE 1-1 Model 335 front view

## 1.1 Product Description

### Features:

- Operates down to 300 mK with appropriate NTC RTD sensors
- Two sensor inputs
- Two configurable PID control loops providing 50 W and 25 W or 75 W and 1 W
- Autotuning automatically calculates PID parameters
- Automatically switch sensor inputs using zones to allow continuous measurement and control from 300 mK to 1505 K
- Custom display setup allows you to label each sensor input
- USB and IEEE-488 interfaces
- Supports diode, RTD, and thermocouple temperature sensors
- Sensor excitation current reversal eliminates thermal EMF errors for resistance sensors
- $\pm 10$  V analog voltage outputs, alarms, and relays

Designed with the user and ease of use in mind, the Model 335 temperature controller offers many user-configurable features and advanced functions that until now have been reserved for more expensive, high-end temperature controllers. The Model 335 is the first two-channel temperature controller available with user configurable heater outputs delivering a total of 75 W of low noise heater power: 50 W and 25 W, or 75 W and 1 W. With that much heater power packed into an affordable half-rack sized instrument, the Model 335 gives you more power and control than ever.

Control outputs are equipped with both hardware and software features allowing you, and not your temperature controller, to easily control your experiments. Output one functions as a current output while output two can be configured in either current or voltage mode. With output two in voltage mode, it functions as a  $\pm 10$  V analog output while still providing 1 W of heater power and full closed loop proportional-integral-derivative (PID) control capability. Alarms and relays are included to help automate secondary control functions. The improved autotuning feature of the Model 335 can be used to automatically calculate PID control parameters, so you spend less time tuning your controller and more time conducting experiments.

The Model 335 supports the industry's most advanced line of cryogenic temperature sensors as manufactured by Lake Shore, including diodes, resistance temperature detectors (RTDs), and thermocouples. The controller's zone tuning feature allows you to measure and control temperatures seamlessly from 300 mK to over 1,500 K. This feature automatically switches temperature sensor inputs when your temperature range goes beyond the useable range of a given sensor. You'll never again have to be concerned with temperature sensor over or under errors and measurement continuity issues.

The intuitive front panel layout and keypad logic, bright vacuum fluorescent display, and LED indicators enhance the user-friendly front panel interface of the Model 335. Four standard display modes are offered to accommodate different instrument configurations and user preferences. Say goodbye to sticky notes and hand written labels, as the ability to custom label sensor inputs eliminates the guesswork in remembering or determining the location to which a sensor input is associated. These features, combined with USB and IEEE-488 interfaces and intuitive menu structure and logic supports efficiency and ease of use.

As a replacement to our popular Model 331 and 332 temperature controllers, the Model 335 offers software emulation modes for literal drop-in compatibility. The commands you are accustomed to sending to the Model 331 and 332 will either be interpreted directly or translated to the most appropriate Model 335 setting. The Model 335 comes standard-equipped with all of the functionality of the controllers it replaces, but offers additional features that save you time and money. With the Model 335, you get a temperature controller you control from the world leader in cryogenic thermometry.

### 1.1.1 Sensor Inputs

The Model 335 offers two standard sensor inputs that are compatible with diode and RTD temperature sensors. The field-installable Model 3060 option adds thermocouple functionality to both inputs.

Sensor inputs feature a high-resolution 24-bit analog-to-digital converter and each of the two powered outputs function as separate current sources. Both sensor inputs are optically isolated from other circuits to reduce noise and to deliver repeatable sensor measurements. Current reversal eliminates thermal electromagnetic field (EMF) errors in resistance sensors. Ten excitation currents facilitate temperature measurement and control down to 300 mK using appropriate negative temperature coefficient (NTC) RTDs. Autorange mode automatically scales excitation current in NTC RTDs to reduce self heating at low temperatures as sensor resistance changes by many orders of magnitude. Temperatures down to 1.4 K can be measured and controlled using silicon or GaAlAs diodes. Software selects the appropriate excitation current and signal gain levels when the sensor type is entered via the instrument front panel. To increase your productivity, the unique zone setting feature automatically switches sensor inputs, enabling you to measure temperatures from 300 mK to over 1,500 K without interrupting your experiment.

The Model 335 includes standard temperature sensor response curves for silicon diodes, platinum RTDs, ruthenium oxide RTDs, and thermocouples. Non-volatile memory can also store up to 39 200-point CalCurves for Lake Shore calibrated temperature sensors or user curves. A built-in SoftCal algorithm can be used to generate curves for silicon diodes and platinum RTDs that can be stored as user curves. Temperature sensor calibration data can be easily loaded into the Model 335 temperature controller and manipulated using the Lake Shore curve handler software program.

## 1.1.2 Temperature Control

Providing a total of 75 W of heater power, the Model 335 is the most powerful half rack temperature controller available. Designed to deliver very clean heater power, precise temperature control is ensured throughout your full scale temperature range for excellent measurement reliability, efficiency and throughput. Two independent PID control outputs can be configured to supply 50 W and 25 W or 75 W and 1 W of heater power. Precise control output is calculated based on your temperature set-point and feedback from the control sensor. Wide tuning parameters accommodate most cryogenic cooling systems and many high-temperature ovens commonly used in laboratories. PID values can be manually set for fine control or the improved auto-tuning feature can automate the tuning process.

The Model 335 autotuning method calculates PID parameters and provides feedback to help build zone tables. The setpoint ramp feature provides smooth, continuous set-point changes and predictable approaches to setpoint without the worry of overshoot or excessive settling times. The instrument's zone tuning feature automatically switches temperature sensor inputs when your temperature range goes beyond the useable range of a given sensor. This feature combined with the instrument's ability to scale the sensor excitation through ten pre-loaded current settings allows the Model 335 to provide continuous measurement and control from 300 mK to 1505 K.

Both control outputs are variable DC current sources referenced to chassis ground. As a factory default, Outputs 1 and 2 provide 50 W and 25 W of continuous power respectively, both to a 50  $\Omega$  or 25  $\Omega$  load. For increased functionality, Output 2 can also be set to voltage mode. When set to voltage mode, it functions as a  $\pm 10$  V analog output while still providing 1 W of heater power and full closed loop PID control capability. While in this mode, output 1 can provide up to 75 W of heater power to a 25  $\Omega$  load.

Temperature limit settings for inputs are provided as a safeguard against system damage. Each input is assigned a temperature limit, and if any input exceeds that limit, both control channels are automatically disabled.

## 1.1.3 Interface

The Model 335 is standard equipped with universal serial bus (USB) and parallel (IEEE-488) interfaces. In addition to gathering data, nearly every function of the instrument can be controlled via computer interface. You can download the Lake Shore curve handler software program to your computer to easily enter and manipulate sensor calibration curves for storage in the instrument's non-volatile memory.

The USB interface emulates an RS-232C serial port at a fixed 57,600 baud rate, but with the physical plug-ins of a USB. It also allows you to download firmware upgrades, ensuring the most current firmware version is loaded into your instrument without having to physically change your instrument.

Both sensor inputs are equipped with a high and low alarm which offers latching and non-latching operation. The two relays can be used in conjunction with the alarms to alert you of a fault condition and perform simple on-off control. Relays can be assigned to any alarm or operated manually.

The  $\pm 10$  V analog voltage output can be configured to send a voltage proportional to temperature to a strip chart recorder or data acquisition system. You may select the scale and data sent to the output, including temperature or sensor units.

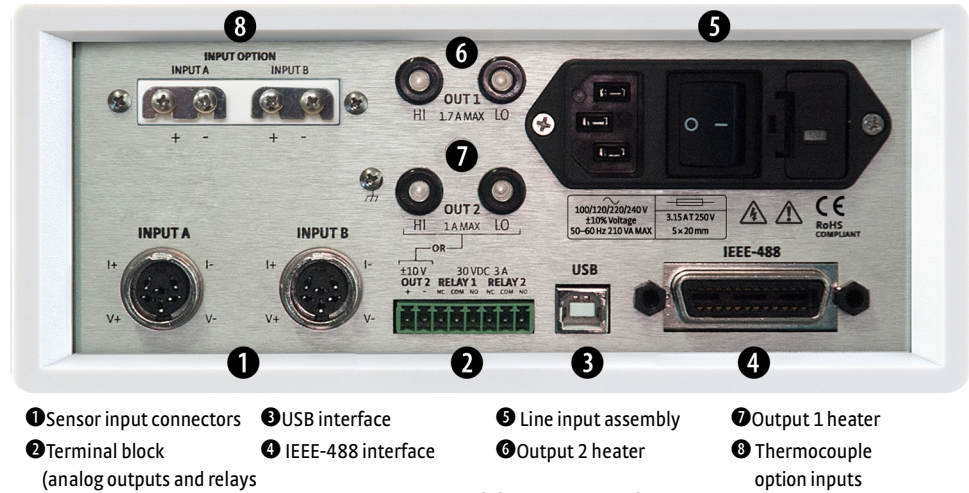

FIGURE 1-2 Model 335 rear panel

### 1.1.4 Configurable Display

The Model 335 offers a bright, vacuum fluorescent display that simultaneously displays up to four readings. You can display both control loops, or if you need to monitor just one input, you can display just that one in greater detail. Or you can custom configure each display location to suit your experiment. Data from any input can be assigned to any of the locations, and your choice of temperature sensor units can be displayed. For added convenience, you can also custom label each sensor input, eliminating the guesswork in remembering or determining the location to which a sensor input is associated.

- Two Input/Output Display with Labels: Standard display option featuring two inputs and associated outputs.
- Custom Display with Labels: Reading locations can be user configured to accommodate application needs. Here, the input names are shown above the measurement readings along with the designated input letters.
- Intuitive Menu Structure: Logical navigation allows you to spend more time on research and less time on setup.



FIGURE 1-3 Displays showing two input/output display with labels, custom display with labels and the intuitive menu structure

### 1.1.5 Model 3060 Thermocouple Input Option

The field installable Model 3060 thermocouple input option adds thermocouple functionality to both inputs. While the option can be easily removed, this is not necessary as the standard inputs remain fully functional when they are not being used to measure thermocouple temperature sensors. Calibration for the option is stored on the card so it can be installed in the field and used with multiple Model 335 temperature controllers without recalibration.



## 1.2 Sensor Selection

Silicon diodes are the best choice for general cryogenic use from 1.4 K to above room temperature. Diodes are economical to use because they follow a standard curve and are interchangeable in many applications. They are not suitable for use in ionizing radiation or magnetic fields.

Cernox™ thin-film RTDs offer high sensitivity and low magnetic field-induced errors over the 0.3 K to 420 K temperature range. Cernox sensors require calibration.

Platinum RTDs offer high uniform sensitivity from 30 K to over 800 K. With excellent reproducibility, they are useful as thermometry standards. They follow a standard curve above 70 K and are interchangeable in many applications.

		Model	Useful range	Magnetic field use
<b>Diodes</b>	Silicon Diode	DT-670-SD	1.4 K to 500 K	$T \geq 60 \text{ K} \ \& \ B \leq 3 \text{ T}$
	Silicon Diode	DT-670E-BR	30 K to 500 K	$T \geq 60 \text{ K} \ \& \ B \leq 3 \text{ T}$
	Silicon Diode	DT-414	1.4 K to 375 K	$T \geq 60 \text{ K} \ \& \ B \leq 3 \text{ T}$
	Silicon Diode	DT-421	1.4 K to 325 K	$T \geq 60 \text{ K} \ \& \ B \leq 3 \text{ T}$
	Silicon Diode	DT-470-SD	1.4 K to 500 K	$T \geq 60 \text{ K} \ \& \ B \leq 3 \text{ T}$
	Silicon Diode	DT-471-SD	10 K to 500 K	$T \geq 60 \text{ K} \ \& \ B \leq 3 \text{ T}$
	GaAlAs Diode	TG-120-P	1.4 K to 325 K	$T > 4.2 \text{ K} \ \& \ B \leq 5 \text{ T}$
	GaAlAs Diode	TG-120-PL	1.4 K to 325 K	$T > 4.2 \text{ K} \ \& \ B \leq 5 \text{ T}$
	GaAlAs Diode	TG-120-SD	1.4 K to 500 K	$T > 4.2 \text{ K} \ \& \ B \leq 5 \text{ T}$
<b>Positive Temperature Coefficient RTDs</b>	100 $\Omega$ Platinum	PT-102/3	14 K to 873 K	$T > 40 \text{ K} \ \& \ B \leq 2.5 \text{ T}$
	100 $\Omega$ Platinum	PT-111	14 K to 673 K	$T > 40 \text{ K} \ \& \ B \leq 2.5 \text{ T}$
	Rhodium-Iron	RF-800-4	1.4 K to 500 K	$T > 77 \text{ K} \ \& \ B \leq 8 \text{ T}$
	Rhodium-Iron	RF-100T/U	1.4 K to 325 K	$T > 77 \text{ K} \ \& \ B \leq 8 \text{ T}$
<b>Negative Temperature Coefficient RTDs</b>	Cernox™	CX-1010	0.3 K to 325 K <sup>1</sup>	$T > 2 \text{ K} \ \& \ B \leq 19 \text{ T}$
	Cernox™	CX-1030-HT	0.3 K to 420 K <sup>1,3</sup>	$T > 2 \text{ K} \ \& \ B \leq 19 \text{ T}$
	Cernox™	CX-1050-HT	1.4 K to 420 K <sup>1</sup>	$T > 2 \text{ K} \ \& \ B \leq 19 \text{ T}$
	Cernox™	CX-1070-HT	4 K to 420 K <sup>1</sup>	$T > 2 \text{ K} \ \& \ B \leq 19 \text{ T}$
	Cernox™	CX-1080-HT	20 K to 420 K <sup>1</sup>	$T > 2 \text{ K} \ \& \ B \leq 19 \text{ T}$
	Germanium	GR-300-AA	0.35 K to 100 K <sup>3</sup>	Not recommended
	Germanium	GR-1400-AA	1.8 K to 100 K <sup>3</sup>	Not recommended
	Carbon-Glass	CGR-1-500	1.4 K to 325 K	$T > 2 \text{ K} \ \& \ B \leq 19 \text{ T}$
	Carbon-Glass	CGR-1-1000	1.7 K to 325 K <sup>2</sup>	$T > 2 \text{ K} \ \& \ B \leq 19 \text{ T}$
	Carbon-Glass	CGR-1-2000	2 K to 325 K <sup>2</sup>	$T > 2 \text{ K} \ \& \ B \leq 19 \text{ T}$
	Rox™	RX-102	0.3 K to 40 K <sup>3</sup>	$T > 2 \text{ K} \ \& \ B \leq 10 \text{ T}$
	Rox™	RX-103	1.4 K to 40 K	$T > 2 \text{ K} \ \& \ B \leq 10 \text{ T}$
	Rox™	RX-202	0.3 K to 40 K <sup>3</sup>	$T > 2 \text{ K} \ \& \ B \leq 10 \text{ T}$
	<b>Thermocouples 3060</b>	Type K	9006-006	3.2 K to 1505 K
Type E		9006-004	3.2 K to 934 K	Not recommended
Chromel-AuFe 0.07%		9006-002	1.2 K to 610 K	Not recommended

<sup>1</sup> Non-HT version maximum temperature: 325 K

<sup>2</sup> Low temperature limited by input resistance range

<sup>3</sup> Low temperature specified with self-heating error:  $\leq 5 \text{ mK}$

TABLE 1-1 Sensor temperature range

	Example Lake Shore Sensor	Temperature	Nominal Resistance/Voltage	Typical Sensor Sensitivity <sup>4</sup>	Measurement Resolution: Temperature Equivalents	Electronic Accuracy: Temperature Equivalents	Temperature Accuracy including Electronic Accuracy, CalCurve and Calibrated Sensor	Electronic Control Stability <sup>5</sup> : Temperature Equivalents
Silicon Diode	DT-670-CO-13 with 1.4H calibration	1.4 K	1.664 V	-12.49 mV/K	0.8 mK	±13 mK	±25 mK	±1.6 mK
		77 K	1.028 V	-1.73 mV/K	5.8 mK	±76 mK	±98 mK	±11.6 mK
		300 K	0.5597 V	-2.3 mV/K	4.4 mK	±47 mK	±79 mK	±8.8 mK
		500 K	0.0907 V	-2.12 mV/K	4.7 mK	±40 mK	±90 mK	±9.4 mK
Silicon Diode	DT-470-SD-13 with 1.4H calibration	1.4 K	1.6981 V	-13.1 mV/K	0.8 mK	±13 mK	±25 mK	±1.6 mK
		77 K	1.0203 V	-1.92 mV/K	5.2 mK	±69 mK	±91 mK	±10.4 mK
		300 K	0.5189 V	-2.4 mV/K	4.2 mK	±45 mK	±77 mK	±8.4 mK
		475 K	0.0906 V	-2.22 mV/K	4.5 mK	±38 mK	±88 mK	±9 mK
GaAlAs Diode	TG-120-SD with 1.4H calibration	1.4 K	5.391 V	-97.5 mV/K	0.2 mK	±7 mK	±19 mK	±0.4 mK
		77 K	1.422 V	-1.24 mV/K	16 mK	±180 mK	±202 mK	±32 mK
		300 K	0.8978 V	-2.85 mV/K	7 mK	±60 mK	±92 mK	±14 mK
		475 K	0.3778 V	-3.15 mV/K	6.4 mK	±38 mK	±88 mK	±13 mK
100 Ω Platinum RTD 500 Ω Full Scale	PT-103 with 14J calibration	30 K	3.660 Ω	0.191 Ω/K	1.1 mK	±13 mK	±23 mK	±2.2 mK
		77 K	20.38 Ω	0.423 Ω/K	0.5 mK	±10 mK	±22 mK	±1.0 mK
		300 K	110.35 Ω	0.387 Ω/K	5.2 mK	±39 mK	±62 mK	±10.4 mK
		500 K	185.668 Ω	0.378 Ω/K	5.3 mK	±60 mK	±106 mK	±10.6 mK
Cernox™	CX-1010-SD with 0.3L calibration	0.3 K	2322.4 Ω	-10785 Ω/K	8.5 μK	±0.1 mK	±3.6 mK	±17 μK
		0.5 K	1248.2 Ω	-2665.2 Ω/K	26 μK	±0.2 mK	±4.7 mK	±52 μK
		4.2 K	277.32 Ω	-32.209 Ω/K	140 μK	±3.8 mK	±8.8 mK	±280 μK
		300 K	30.392 Ω	-0.0654 Ω/K	23 mK	±339 mK	±414 mK	±46 mK
Cernox™	CX-1050-SD-HT <sup>6</sup> with 1.4M calibration	1.4 K	26566 Ω	-48449 Ω/K	20 μK	±0.3 mK	±5.3 mK	±40 μK
		4.2 K	3507.2 Ω	-1120.8 Ω/K	196 μK	±2.1 mK	±7.1 mK	±392 μK
		77 K	205.67 Ω	-2.4116 Ω/K	1.9 mK	±38 mK	±54 mK	±3.8 mK
		420 K	45.03 Ω	-0.0829 Ω/K	18 mK	±338 mK	±403 mK	±36 mK
Germanium	GR-300-AA with 0.3D calibration	0.35 K	18225 Ω	-193453 Ω/K	4 μK	±48 μK	±4.2 mK	±8 μK
		1.4 K	449 Ω	-581 Ω/K	41 μK	±481 μK	±4.7 mK	±82 μK
		4.2 K	94 Ω	-26.6 Ω/K	56 μK	±1.8 mK	±6.8 mK	±112 μK
		100 K	2.7 Ω	-0.024 Ω/K	6.3 mK	±152 mK	±175 mK	±12.6 mK
Germanium	GR-1400-AA with 1.4D calibration	1.8 K	15288 Ω	-26868 Ω/K	28 μK	±302 μK	±4.5 mK	±56 μK
		4.2 K	1689 Ω	-862 Ω/K	91 μK	±900 μK	±5.1 mK	±182 μK
		10 K	253 Ω	-62.0 Ω/K	73 μK	±1.8 mK	±6.8 mK	±146 μK
		100 K	2.8 Ω	-0.021 Ω/K	7.1 mK	±177 mK	±200 mK	±14.2 mK
Carbon-Glass	CGR-1-500 with 1.4L calibration	1.4 K	103900 Ω	-520000 Ω/K	13 μK	±0.1 mK	±4.1 mK	±26 μK
		4.2 K	584.6 Ω	-422.3 Ω/K	63 μK	±0.8 mK	±4.8 mK	±126 μK
		77 K	14.33 Ω	-0.098 Ω/K	4.6 mK	±108 mK	±133 mK	±9.2 mK
		300 K	8.55 Ω	-0.0094 Ω/K	16 mK	±760 mK	±865 mK	±32 mK
Rox™	RX-102A-AA with 0.3B calibration	0.5 K	3701 Ω	-5478 Ω/K	41 μK	±0.5 mK	±5 mK	±82 μK
		1.4 K	2005 Ω	-667 Ω/K	128 μK	±1.4 mK	±6.4 mK	±256 μK
		4.2 K	1370 Ω	-80.3 Ω/K	902 μK	±8 mK	±24 mK	±1.8 mK
		40 K	1049 Ω	-1.06 Ω/K	62 mK	±500 mK	±537 K	±124 mK
Thermocouple 50 mV 3060-F	Type K	75 K	-5862.9 μV	15.6 μV/K	26 mK	±0.25 K <sup>7</sup>	Calibration not available from Lake Shore	±52 mK
		300 K	1075.3 μV	40.6 μV/K	10 mK	±0.038 K <sup>7</sup>		±20 mK
		600 K	13325 μV	41.7 μV/K	10 mK	±0.184 K <sup>7</sup>		±20 mK
		1505 K	49998.3 μV	36.006 μV/K	11 mK	±0.73 K <sup>7</sup>		±22 mK

<sup>4</sup> Typical sensor sensitivities were taken from representative calibrations for the sensor listed

<sup>5</sup> Control stability of the electronics only, in an ideal thermal system

<sup>6</sup> Non-HT version maximum temperature: 325 K

<sup>7</sup> Accuracy specification does not include errors from room temperature compensation

TABLE 1-2 Typical sensor performance

## 1.3 Model 335 Specifications

### 1.3.1 Input Specifications

	Sensor temperature coefficient	Input range	Excitation current	Display resolution	Measurement resolution	Electronic accuracy (at 25 °C)	Measurement temperature coefficient	Electronic stability <sup>1</sup>
<b>Diode</b>	Negative	0 V to 2.5 V	10 $\mu$ A $\pm$ 0.05% <sup>2,3</sup>	100 $\mu$ V	10 $\mu$ V	$\pm$ 80 $\mu$ V $\pm$ 0.005% of rdg	(10 $\mu$ V + 0.0005% of rdg)/°C	$\pm$ 20 $\mu$ V
		0 V to 10 V	10 $\mu$ A $\pm$ 0.05% <sup>2,3</sup>	1 mV	20 $\mu$ V	$\pm$ 80 $\mu$ V $\pm$ 0.01% of rdg	(20 $\mu$ V + 0.0005% of rdg)/°C	$\pm$ 40 $\mu$ V
<b>PTC RTD</b>	Positive	0 $\Omega$ to 10 $\Omega$	1 mA <sup>4</sup>	1 m $\Omega$	0.2 m $\Omega$	$\pm$ 0.002 $\Omega$ $\pm$ 0.01% of rdg	(0.01 m $\Omega$ + 0.001% of rdg)/°C	$\pm$ 0.4 m $\Omega$
		0 $\Omega$ to 30 $\Omega$	1 mA <sup>4</sup>	1 m $\Omega$	0.2 m $\Omega$	$\pm$ 0.002 $\Omega$ $\pm$ 0.01% of rdg	(0.03 m $\Omega$ + 0.001% of rdg)/°C	$\pm$ 0.4 m $\Omega$
		0 $\Omega$ to 100 $\Omega$	1 mA <sup>4</sup>	10 m $\Omega$	2 m $\Omega$	$\pm$ 0.004 $\Omega$ $\pm$ 0.01% of rdg	(0.1 m $\Omega$ + 0.001% of rdg)/°C	$\pm$ 4 m $\Omega$
		0 $\Omega$ to 300 $\Omega$	1 mA <sup>4</sup>	10 m $\Omega$	2 m $\Omega$	$\pm$ 0.004 $\Omega$ $\pm$ 0.01% of rdg	(0.3 m $\Omega$ + 0.001% of rdg)/°C	$\pm$ 4 m $\Omega$
		0 $\Omega$ to 1 k $\Omega$	1 mA <sup>4</sup>	100 m $\Omega$	20 m $\Omega$	$\pm$ 0.04 $\Omega$ $\pm$ 0.02% of rdg	(1 m $\Omega$ + 0.001% of rdg)/°C	$\pm$ 40 m $\Omega$
		0 $\Omega$ to 3 k $\Omega$	1 mA <sup>4</sup>	100 m $\Omega$	20 m $\Omega$	$\pm$ 0.04 $\Omega$ $\pm$ 0.02% of rdg	(3 m $\Omega$ + 0.001% of rdg)/°C	$\pm$ 40 m $\Omega$
		0 $\Omega$ to 10 k $\Omega$	1 mA <sup>4</sup>	1 $\Omega$	200 m $\Omega$	$\pm$ 0.4 $\Omega$ $\pm$ 0.02% of rdg	(10 m $\Omega$ + 0.001% of rdg)/°C	$\pm$ 400 m $\Omega$
<b>NTC RTD 10 mV</b>	Negative	0 $\Omega$ to 10 $\Omega$	1 mA <sup>4</sup>	1 m $\Omega$	0.15 m $\Omega$	$\pm$ 0.002 $\Omega$ $\pm$ 0.06% of rdg	(0.01 m $\Omega$ + 0.001% of rdg)/°C	$\pm$ 0.3 m $\Omega$
		0 $\Omega$ to 30 $\Omega$	300 $\mu$ A <sup>4</sup>	1 m $\Omega$	0.45 m $\Omega$	$\pm$ 0.002 $\Omega$ $\pm$ 0.06% of rdg	(0.03 m $\Omega$ + 0.0015% of rdg)/°C	$\pm$ 0.9 m $\Omega$
		0 $\Omega$ to 100 $\Omega$	100 $\mu$ A <sup>4</sup>	10 m $\Omega$	1.5 m $\Omega$	$\pm$ 0.01 $\Omega$ $\pm$ 0.04% of rdg	(0.1 m $\Omega$ + 0.001% of rdg)/°C	$\pm$ 3 m $\Omega$
		0 $\Omega$ to 300 $\Omega$	30 $\mu$ A <sup>4</sup>	10 m $\Omega$	4.5 m $\Omega$	$\pm$ 0.01 $\Omega$ $\pm$ 0.04% of rdg	(0.3 m $\Omega$ + 0.0015% of rdg)/°C	$\pm$ 9 m $\Omega$
		0 $\Omega$ to 1 k $\Omega$	10 $\mu$ A <sup>4</sup>	100 m $\Omega$	15 m $\Omega$ + 0.002% of rdg	$\pm$ 0.1 $\Omega$ $\pm$ 0.04% of rdg	(1 m $\Omega$ + 0.001% of rdg)/°C	$\pm$ 30 m $\Omega$ $\pm$ 0.004% of rdg
		0 $\Omega$ to 3 k $\Omega$	3 $\mu$ A <sup>4</sup>	100 m $\Omega$	45 m $\Omega$ + 0.002% of rdg	$\pm$ 0.1 $\Omega$ $\pm$ 0.04% of rdg	(3 m $\Omega$ + 0.0015% of rdg)/°C	$\pm$ 90 m $\Omega$ $\pm$ 0.004% of rdg
		0 $\Omega$ to 10 k $\Omega$	1 $\mu$ A <sup>4</sup>	1 $\Omega$	150 m $\Omega$ + 0.002% of rdg	$\pm$ 1.0 $\Omega$ $\pm$ 0.04% of rdg	(10 m $\Omega$ + 0.001% of rdg)/°C	$\pm$ 300 m $\Omega$ $\pm$ 0.004% of rdg
		0 $\Omega$ to 30 k $\Omega$	300 nA <sup>4</sup>	1 $\Omega$	450 m $\Omega$ + 0.002% of rdg	$\pm$ 2.0 $\Omega$ $\pm$ 0.04% of rdg	(30 m $\Omega$ + 0.0015% of rdg)/°C	$\pm$ 900 m $\Omega$ $\pm$ 0.004% of rdg
		0 $\Omega$ to 100 k $\Omega$	100 nA <sup>4</sup>	10 $\Omega$	1.5 $\Omega$ + 0.005% of rdg	$\pm$ 10.0 $\Omega$ $\pm$ 0.04% of rdg	(100 m $\Omega$ + 0.002% of rdg)/°C	$\pm$ 3 $\Omega$ $\pm$ 0.01% of rdg
<b>Thermocouple</b>	Positive	$\pm$ 50 mV	NA	1 $\mu$ V	0.4 $\mu$ V	$\pm$ 1 $\mu$ V $\pm$ 0.05% of rdg <sup>5</sup>	(0.1 $\mu$ V + 0.001% of rdg)/°C	$\pm$ 0.8 $\mu$ V

<sup>1</sup> Control stability of the electronics only, in ideal thermal system

<sup>2</sup> Current source error has negligible effect on measurement accuracy

<sup>3</sup> Diode input excitation can be set to 1 mA

<sup>4</sup> Current source error is removed during calibration

<sup>5</sup> Accuracy specification does not include errors from room temperature compensation

TABLE 1-3 Input specifications

### 1.3.2 Sensor Input Configuration

	Diode/RTD	Thermocouple
<b>Measurement type</b>	4-lead differential	2-lead differential, room temperature compensated
<b>Excitation</b>	Constant current with current reversal for RTDs	NA
<b>Supported sensors</b>	<b>Diodes:</b> Silicon, GaAlAs <b>RTDs:</b> 100 Ω Platinum, 1000 Ω Platinum Germanium, Carbon-Glass, Cernox™, and Rox™	Most thermocouple types
<b>Standard curves</b>	DT-470, DT-670, DT-500-D, DT-500-E1, PT-100, PT-1000, RX-102A, RX-202A	Type E, Type K, Type T, AuFe 0.07% vs. Cr, AuFe 0.03% vs. CR
<b>Input connector</b>	6-pin DIN	Screw terminals in a ceramic isothermal block

TABLE 1-4 Sensor input configuration

### 1.3.3 Thermometry

<b>Number of inputs</b>	2
<b>Input configuration</b>	Inputs can be configured from the front panel to accept any of the supported input types. Thermocouple inputs require an optional input card that can be installed in the field. Once installed, the thermocouple input can be selected from the front panel like any other input type.
<b>Isolation</b>	Sensor inputs optically isolated from other circuits but not each other
<b>A/D resolution</b>	24-bit
<b>Input accuracy</b>	Sensor dependent, refer to Input Specifications table
<b>Measurement resolution</b>	Sensor dependent, refer to Input Specifications table
<b>Maximum update rate</b>	10 rdg/s on each input, 5 rdg/s when configured as 100 kΩ NTC RTD with reversal on
<b>Autorange</b>	Automatically selects appropriate NTC RTD or PTC RTD range
<b>User curves</b>	Room for 39 200-point CalCurves™ or user curves
<b>SoftCal™</b>	Improves accuracy of DT-470 diode to ±0.25 K from 30 K to 375 K; improves accuracy of platinum RTDs to ±0.25 K from 70 K to 325 K; stored as user curves
<b>Math</b>	Maximum and minimum
<b>Filter</b>	Averages 2 to 64 input readings

### 1.3.4 Control

There are two control outputs.

#### 1.3.4.1 Heater Outputs (Outputs 1 and 2)

<b>Control type</b>	Closed loop digital PID with manual heater output or open loop; warm up mode (Output 2 only)
<b>Update rate</b>	10/s
<b>Tuning</b>	Autotune (one loop at a time), PID, PID zones
<b>Control stability</b>	Sensor dependent, see Input Specifications table
<b>PID control settings</b>	
<b>Proportional (gain)</b>	0 to 1000 with 0.1 setting resolution
<b>Integral (reset)</b>	1 to 1000 (1000/s) with 0.1 setting resolution
<b>Derivative (rate)</b>	1 to 200% with 1% resolution
<b>Manual output</b>	0 to 100% with 0.01% setting resolution
<b>Zone control</b>	10 temperature zones with P, I, D, manual heater out, heater range, control channel, ramp rate
<b>Setpoint ramping</b>	0.1 K/min to 100 K/min

Type	Variable DC current source		
Control modes	Closed loop digital PID with manual output or open loop		
D/A resolution	16-bit		
	25 $\Omega$ setting	50 $\Omega$ setting	
Max power	75 W*	50 W	50 W
Max current	1.73 A	1.41 A	1 A
Voltage compliance (min)	43.3 V	35.4 V	50 V
Heater load for max power	25 $\Omega$	25 $\Omega$	50 $\Omega$
Heater load range	10 $\Omega$ to 100 $\Omega$		
Ranges	3 (decade steps in power)		
Heater noise	0.12 $\mu$ A RMS (dominated by line frequency and its harmonics)		
Heater connector	Dual banana		
Grounding	Output referenced to chassis ground		
Safety limits	Curve temperature, power up heater off, short circuit protection		

\*75 W only available when Output 2 is in voltage mode

TABLE 1-5 Output 1

Type	Variable DC current source or voltage source		
	Current mode	Voltage mode	
Control modes	Closed loop digital PID with manual output, zone, open loop	Closed loop digital PID with manual output, zone, open loop, warm up, monitor out	
D/A resolution	15-bit		16-bit (bipolar)/15-bit (unipolar)
	25 $\Omega$ setting	50 $\Omega$ setting	N/A
Max power	25 W	25 W	1 W
Max current	1 A	0.71 A	100 mA
Voltage compliance (min)	25 V	35.4 V	$\pm$ 10 V
Heater load for max power	25 $\Omega$	50 $\Omega$	100 $\Omega$
Heater load range	10 $\Omega$ to 100 $\Omega$		100 $\Omega$ min (short circuit protected)
Ranges	3 (decade steps in power)		N/A
Heater noise	0.12 $\mu$ A RMS		0.3 mV RMS
Heater connector	Dual banana		Detachable terminal block
Grounding	Output referenced to chassis ground		
Safety limits	Curve temperature, power up heater off, short circuit protection		

TABLE 1-6 Output 2

#### Warm up heater mode settings (Output 2 only)

Warm up percentage	0 to 100% with 1% resolution
Warm up mode	Continuous control or auto-off

#### Monitor Output settings (Output 2 voltage only)

Scale	User selected
Data source	Temperature or sensor units
Settings	Input, source, top of scale, bottom of scale or manual
Update rate	10/s
Range	$\pm$ 10 V
Resolution	16-bit, 0.3 mV
Accuracy	$\pm$ 2.5 mV
Noise	0.3 mV RMS
Minimum load resistance	100 $\Omega$ (short-circuit protected)
Connector	Detachable terminal block

### 1.3.5 Front Panel

<b>Display</b>	2-line by 20-character, 9 mm character height, vacuum fluorescent display
<b>Number of reading displays</b>	1 to 4
<b>Display units</b>	K, °C, V, mV, Ω
<b>Reading source</b>	Temperature, sensor units, max, and min
<b>Display update rate</b>	2 rdg/s
<b>Temperature display resolution</b>	0.001° from 0° to 99.999°, 0.01° from 100° to 999.99°, 0.1° above 1000°
<b>Sensor units display resolution</b>	Sensor dependent, to 5 digits
<b>Other displays</b>	Sensor name, setpoint, heater range, heater output, and PID
<b>Setpoint setting resolution</b>	Same as display resolution (actual resolution is sensor dependent)
<b>Heater output display</b>	Numeric display in percent of full scale for power or current
<b>Heater output resolution</b>	1%
<b>Display annunciators</b>	Control input, alarm, tuning
<b>LED annunciators</b>	Remote, alarm, control outputs
<b>Keypad</b>	25-key silicone elastomer keypad
<b>Front panel features</b>	Front panel curve entry, display brightness control, and keypad lock-out

### 1.3.6 Interface

<b>IEEE-488.2</b>	
<b>Capabilities</b>	SH1, AH1, T5, L4, SR1, RL1, PPO, DC1, DTO, CO, E1
<b>Reading rate</b>	To 10 rdg/s on each input
<b>Software support</b>	LabVIEW™ driver (contact Lake Shore for availability)
<b>USB</b>	
<b>Function</b>	Emulates a standard RS-232 serial port
<b>Baud Rate</b>	57,600
<b>Connector</b>	B-type USB connector
<b>Reading rate</b>	To 10 rdg/s on each input
<b>Software support</b>	LabVIEW™ driver (contact Lake Shore for availability)
<b>Special interface features</b>	Model 331/332 command emulation mode
<b>Alarms</b>	
<b>Number</b>	2, high and low for each input
<b>Data source</b>	Temperature or sensor units
<b>Settings</b>	Source, high setpoint, low setpoint, deadband, latching or non-latching, audible on/off, and visible on/off
<b>Actuators</b>	Display annunciator, beeper, and relays
<b>Relays</b>	
<b>Number</b>	2
<b>Contacts</b>	Normally open (NO), normally closed (NC), and common (C)
<b>Contact rating</b>	30 VDC at 3 A
<b>Operation</b>	Activate relays on high, low, or both alarms for any input, or manual mode
<b>Connector</b>	Detachable terminal block

### 1.3.7 General

<b>Ambient temperature</b>	15 °C to 35 °C at rated specifications; 5 °C to 40 °C at reduced specifications
<b>Power requirement</b>	100, 120, 220, 240, VAC, ±10%, 50 or 60 Hz, 210 VA
<b>Size</b>	217 mm W × 90 mm H × 317 mm D (8.5 in × 3.5 in × 14.5 in), half rack
<b>Weight</b>	7.6 kg (16.8 lb)
<b>Approval</b>	CE mark



## 1.4 Safety Summary and Symbols

Observe these general safety precautions during all phases of instrument operation, service, and repair. Failure to comply with these precautions or with specific warnings elsewhere in this manual violates safety standards of design, manufacture, and intended instrument use. Lake Shore Cryotronics, Inc. assumes no liability for Customer failure to comply with these requirements.

The Model 335 protects the operator and surrounding area from electric shock or burn, mechanical hazards, excessive temperature, and spread of fire from the instrument. Environmental conditions outside of the conditions below may pose a hazard to the operator and surrounding area.

- Indoor use
- Altitude to 2000 m
- Temperature for safe operation: 5 °C to 40 °C
- Maximum relative humidity: 80% for temperature up to 31 °C decreasing linearly to 50% at 40 °C
- Power supply voltage fluctuations not to exceed  $\pm 10\%$  of the nominal voltage
- Overvoltage category II
- Pollution degree 2
- IPX0: not protected against harmful ingress of water

### *Ground the Instrument*

To minimize shock hazard, the instrument is equipped with a 3-conductor AC power cable. Plug the power cable into an approved 3-contact electrical outlet or use a 3-contact adapter with the grounding wire (green) firmly connected to an electrical ground (safety ground) at the power outlet. The power jack and mating plug of the power cable meet Underwriters Laboratories (UL) and International Electrotechnical Commission (IEC) safety standards.

### *Ventilation*

The instrument has ventilation holes in its side covers. Do not block these holes when the instrument is operating.

### *Do Not Operate in an Explosive Atmosphere*

Do not operate the instrument in the presence of flammable gases or fumes. Operation of any electrical instrument in such an environment constitutes a definite safety hazard.

### *Keep Away from Live Circuits*

Operating personnel must not remove instrument covers. Refer component replacement and internal adjustments to qualified maintenance personnel. Do not replace components with power cable connected. To avoid injuries, always disconnect power and discharge circuits before touching them.

### *Do Not Substitute Parts or Modify Instrument*

Do not install substitute parts or perform any unauthorized modification to the instrument. Return the instrument to an authorized Lake Shore Cryotronics, Inc. representative for service and repair to ensure that safety features are maintained.

### *Cleaning*

Do not submerge instrument. Clean only with a damp cloth and mild detergent. Exterior only.













	Direct current (power line)		Equipment protected throughout by double insulation or reinforces insulation (equivalent to Class II of IEC 536—see Annex H)
	Alternating current (power line)		CAUTION: High voltages; danger of electric shock; background color: yellow; symbol and outline: black
	Alternating or direct current (power line)		CAUTION or WARNING: See instrument documentation; background color: yellow; symbol and outline: black
	Three-phase alternating current (power line)		
	Earth (ground) terminal		
	Protective conductor terminal		
	Frame or chassis terminal		
	On (supply)		
	Off (supply)		

FIGURE 1-4 Safety symbols

# Chapter 2: Cooling System Design and Temperature Control

## 2.1 General

Selecting the proper cryostat or cooling source is probably the most important decision in designing a temperature control system. The cooling source defines the minimum temperature, cool-down time, and cooling power. Information on choosing a cooling source is beyond the scope of this manual. This chapter provides information on how to get the best temperature measurement and control from cooling sources with proper setup including sensor and heater installation.

## 2.2 Temperature Sensor Selection

This section attempts to answer some of the basic questions concerning temperature sensor selection. Additional useful information on temperature sensor selection is available in the Lake Shore Temperature Measurement and Control Catalog. The catalog has a large reference section that includes sensor characteristics and sensor selection criteria.

### 2.2.1 Temperature Range

Several important sensor parameters must be considered when choosing a sensor. The first is temperature range. The experimental temperature range must be known when choosing a sensor. Some sensors can be damaged by temperatures that are either too high or too low. Manufacturer recommendations should always be followed.

Sensor sensitivity changes with temperature and can limit the useful range of a sensor. It is important not to specify a range larger than necessary. If an experiment is being done at liquid helium temperature, a very high sensitivity is needed for good measurement resolution at that temperature. That same resolution may not be required to monitor warm up to room temperature. Two different sensors may be required to tightly cover the range from base temperature to room temperature, but lowering the resolution requirement on warm up may allow a less expensive, one sensor solution.

Another thing to consider when choosing a temperature sensor is that instruments like the Model 335 are not able to read some sensors over their entire temperature range. Lake Shore sells calibrated sensors that operate down to 20 millikelvin (mK), but the Model 335 is limited to above 300 mK in its standard configuration.

### 2.2.2 Sensor Sensitivity

Temperature sensor sensitivity is a measure of how much a sensor signal changes when the temperature changes. It is an important sensor characteristic because so many measurement parameters are related to it. Resolution, accuracy, noise floor, and even control stability depend on sensitivity. Many sensors have different sensitivities at different temperatures. For example, a platinum sensor has good sensitivity at higher temperatures, but has limited use below 30 K because its sensitivity drops sharply. It is difficult to determine if a sensor has adequate sensitivity over the experimental temperature range. This manual has specifications (section 1.3) that include sensor sensitivity translated into temperature resolution and accuracy at different points. This is typical sensor response and can be used as a guide when choosing a sensor to be used with the Model 335.

### 2.2.3 Environmental Conditions

The experimental environment is also important when choosing a sensor. Environmental factors such as high vacuum, magnetic field, corrosive chemicals, or even radiation can limit the use of some types of sensors. Lake Shore has devoted much time to developing sensor packages that withstand the temperatures, vacuum levels, and bonding materials found in typical cryogenic cooling systems.

Experiments done in magnetic fields are very common. Field dependence of temperature sensors is an important selection criteria for sensors used in these experiments. This manual briefly qualifies the field dependence of most common sensors in the specifications (section 1.3). Detailed field dependence tables are included in the Lake Shore Temperature Measurement and Control Catalog. When available, specific data on other environmental factors is also included in the catalog.

### 2.2.4 Measurement Accuracy

Temperature measurements have several sources of uncertainty that reduce accuracy. Be sure to account for errors induced by both the sensor and the instrumentation when computing accuracy. The instrument has measurement error in reading the sensor signal, and error in calculating a temperature using a temperature response curve. Error results from the sensor being compared to a calibration standard and the temperature response of a sensor will shift with time and with repeated thermal cycling (from very cold temperatures to room temperature). Instrument and sensor manufacturers specify these errors, but there are things you can do to maintain good accuracy. For example, choose a sensor that has good sensitivity in the most critical temperature range, as sensitivity can minimize the effect of most error sources. Install the sensor properly following guidelines in section 2.4. Have the sensor and instrument periodically recalibrated, or in some other way null the time dependent errors. Use a sensor calibration that is appropriate for the accuracy requirement.

### 2.2.5 Sensor Package

Many types of sensors can be purchased in different packages. Some types of sensors can even be purchased as bare chips without any package. A sensor package generally determines its size, thermal and electrical contact to the outside, and sometimes limits temperature range. When different packages are available for a sensor, you should consider the mounting surface for the sensor and how leads will be thermally anchored when choosing.

## 2.3 Sensor Calibrations

There can sometimes be confusion in the difficult task of choosing the right sensor, getting it calibrated, translating the calibration data into a temperature response curve that the Model 335 can understand, and then getting the curve loaded into the instrument. Lake Shore provides a variety of calibration services to fit different accuracy requirements and budgets.

<b>Best</b>	Precision calibration	All sensors can be calibrated over various temperature ranges. Lake Shore has defined calibration ranges available for each sensor type.
<b>Better</b>	SoftCal™	An abbreviated calibration (2-point: 77 K and 305 K; 3-point: 4.2 K, 77 K, and 305 K; or 3-point: 77 K, 305 K, and 480 K), which is available for 400 Series silicon diodes and platinum sensors
<b>Good</b>	Sensors using standard curves	Silicon diodes follow standard curves
		Platinum resistors follow standard curves
		Ruthenium oxide (Rox™) resistors follow standard curves
		Thermocouples follow standard curves
		GaAlAs diode, carbon-glass, Cernox™, germanium, and rhodium-iron sensors can be purchased uncalibrated, but must be calibrated to accurately read in temperature units

TABLE 2-1 *Sensor diode sensor calibrations*

### 2.3.1 Precision Calibration

Calibration is done by comparing a sensor with an unknown temperature response to an accepted standard. Lake Shore temperature standards are traceable to the U.S. National Institute of Standards and Testing (NIST) or the National Physical Laboratory in Great Britain. These standards allow Lake Shore to calibrate sensors from 20 mK to above room temperature. Calibrated sensors are more expensive than uncalibrated sensors of the same type because of the labor, cryogen use, and capital equipment used in the process.

Precision calibration provides the most accurate temperature sensors available from Lake Shore. Uncertainty from sensor calibration is almost always smaller than the error contributed by the Model 335. The Lake Shore Temperature Measurement and Control Catalog has complete accuracy specifications for calibrated sensors.

Calibrated sensors include the measured test data printed and plotted, the coefficients of a Chebychev polynomial that have been fitted to the data, and two tables of data points to be used as interpolation tables. Both interpolation tables are optimized to allow accurate temperature conversion. The smaller table, called a break-point interpolation table, is sized to fit into instruments like the Model 335, where it is called a temperature response curve.

It is important to look at instrument specifications before ordering calibrated sensors. A calibrated sensor is required when a sensor does not follow a standard curve and you wish to display in temperature. Otherwise the Model 335 will operate in sensor units like ohms or volts. The Model 335 may not work over the full temperature range of some sensors. The standard inputs are limited to operation above 300 mK even with sensors that can be calibrated to 20 mK.

### 2.3.2 SoftCal™

SoftCal™ is a good solution for applications that do not require the accuracy of a precision calibration. The SoftCal™ algorithm uses the well-behaved nature of sensors that follow a standard curve to improve the accuracy of individual sensors. A few known temperature points are required to perform SoftCal™. The Model 335 can also perform a SoftCal™ calibration. You must provide one, two, or three known temperature reference points. The range and accuracy of the calibration is based on these points (section 5.9).

Lake Shore offers two or three-point SoftCal™ calibrated sensors that include both the large interpolation table and the smaller breakpoint interpolation table for 400 Series diodes and platinum sensors.

### 2.3.3 Sensors Using Standard Curves

Some types of sensors behave in a very predictable manner and a standard temperature response curve can be created for them. Standard curves are a convenient and inexpensive way to get reasonable temperature accuracy. Sensors that have a standard curve are often used when interchangeability is important. Some individual sensors are selected for their ability to match a published standard curve, but in general these sensors do not provide the accuracy of a calibrated sensor. For convenience, the Model 335 has several standard curves included in firmware.

### 2.3.4 Curve Handler™

Lake Shore provides a software application called Curve Handler™, which makes loading temperature curves into the Model 335 a very simple process. The program can copy curves from properly formatted files into the Model 335 user curve locations. You can use it to read curves from the Model 335 and save them to files. A CD is provided with Lake Shore calibrated sensors that contains all the proper formats to load curves using the Curve Handler™ software program.

The Curve Handler™ application is a 32-bit Microsoft® Windows® application that must be installed on a Windows® PC. This version works with the IEEE-488 and USB computer interfaces on the Model 335, and allows the temperature curves to be manipulated directly in the program window. This version will also work with all existing Lake Shore temperature controller and temperature monitor instruments. Curve Handler™ is available free of charge from the Lake Shore website at [www.lakeshore.com](http://www.lakeshore.com).

## 2.4 Sensor Installation

This section highlights some of the important elements of proper sensor installation. For more detailed information, Lake Shore sensors are shipped with installation instructions that cover that specific sensor type and package. The Lake Shore Temperature Measurement and Control Catalog includes an installation section as well. To further help you properly install sensors, Lake Shore offers a line of cryogenic accessories. Many of the materials discussed are available through Lake Shore and can be ordered with sensors or instruments.

### 2.4.1 Mounting Materials

Choosing appropriate mounting materials is very important in a cryogenic environment. The high vacuum used to insulate cryostats is one consideration. Materials used in these applications should have a low vapor pressure so they do not evaporate or out-gas and spoil the vacuum insulation. Metals and ceramics do not have this problem, but greases and varnishes must be checked. Another consideration is the wide extremes in temperature most sensors are exposed to. The linear expansion coefficient of materials becomes important when temperature changes are so large. Never try to permanently bond materials with linear expansion coefficients that differ by more than three. A flexible mounting scheme should be used or the parts will break apart, potentially damaging them. The thermal expansion or contraction of rigid clamps or holders could crush fragile samples or sensors that do not have the same coefficient. Thermal conductivity is a property of materials that can change with temperature. Do not assume that a thermal anchor grease that works well at room temperature and above will do the same job at low temperatures.

### 2.4.2 Sensor Location

Finding a good place to mount a sensor in an already crowded cryostat is never easy. There are fewer problems if the entire load and sample holder are at the same temperature. Unfortunately, this is not the case in many systems. Temperature gradients (differences in temperature) exist because there is seldom perfect balance between the cooling source and heat sources. Even in a well-controlled system, unwanted heat sources like thermal radiation and heat conducting through mounting structures can cause gradients. For best accuracy, sensors should be positioned near the sample, so that little or no heat flows between the sample and sensor. This may not, however, be the best location for temperature control as discussed in section 2.4.3.

### 2.4.3 Thermal Conductivity

The ability of heat to flow through a material is called thermal conductivity. Good thermal conductivity is important in any part of a cryogenic system that is intended to be the same temperature. Copper and aluminum are examples of metals that have good thermal conductivity, while stainless steel does not. Non-metallic, electrically-insulating materials like alumina oxide and similar ceramics have good thermal conductivity, while G-10 epoxy-impregnated fiberglass does not. Sensor packages, cooling loads, and sample holders should have good thermal conductivity to reduce temperature gradients. Surprisingly, the connections between thermally conductive mounting surfaces often have very poor thermal conductivity (refer to section 2.4.4 and section 2.4.5).



#### 2.4.4 Contact Area

Thermal contact area greatly affects thermal conduction because a larger area has more opportunity to transfer heat. Even when the size of a sensor package is fixed, thermal contact area can be improved with the use of a gasket material like indium foil and cryogenic grease. A soft gasket material forms into the rough mating surface to increase the area of the two surfaces that are in contact. Good gasket materials are soft, thin, and have good thermal conductivity. They must also withstand the environmental extremes. Indium foil and cryogenic grease are good examples.

#### 2.4.5 Contact Pressure

When sensors are permanently mounted, the solder or epoxy used to hold the sensor act as both gasket and adhesive. Permanent mounting is not a good solution for everyone because it limits flexibility and can potentially damage sensors. Much care should be taken not to overheat or mechanically stress sensor packages. Less permanent mountings require some pressure to hold the sensor to its mounting surface. Pressure greatly improves the action of gasket material to increase thermal conductivity and reduce thermal gradients. A spring clamp is recommended so that different rates of thermal expansion do not increase or decrease pressure with temperature change.

#### 2.4.6 Lead Wire

Different types of sensors come with different types and lengths of electrical leads. In general a significant length of lead wire must be added to the sensor for proper thermal anchoring and connecting to a bulk head connector at the vacuum boundary. The lead wire must be a good electrical conductor, but should not be a good thermal conductor, or heat will transfer down the leads and change the temperature reading of the sensor. Small 30 AWG to 40 AWG wire made of an alloy like phosphor bronze is much better than copper wire. Thin wire insulation is preferred, and twisted wire should be used to reduce the effect of RF noise if it is present. The wire used on the room temperature side of the vacuum boundary is not critical, so copper cable is normally used.

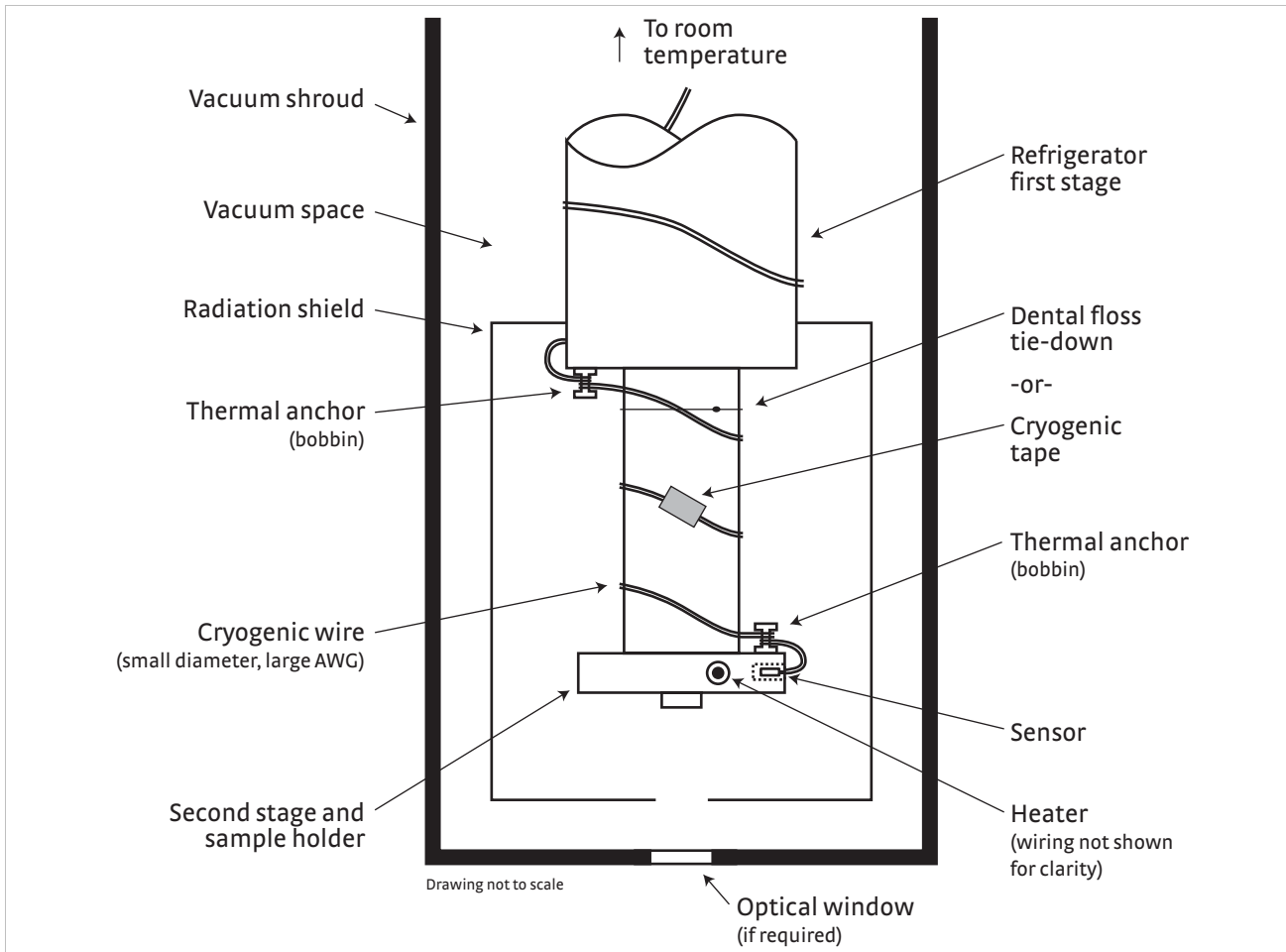

FIGURE 2-1 Typical sensor installation in a mechanical refrigerator

### 2.4.7 Lead Soldering

When additional wire is soldered to short sensor leads, care must be taken not to overheat the sensor. A thermal anchor such as a metal wire clamp or alligator clip will anchor the leads and protect the sensor. Leads should be tinned before bonding to reduce the time that heat is applied to the sensor lead. Solder flux should be cleaned after soldering to prevent corrosion or outgassing in vacuum.

### 2.4.8 Thermal Anchoring Leads

Sensor leads can be a significant source of error if they are not properly anchored. Heat will transfer down even small leads and alter the sensor reading. The goal of thermal anchoring is to cool the leads to a temperature as close to the sensor as possible. This can be accomplished by putting a significant length of lead wire in thermal contact with every cooled surface between room temperature and the sensor. Lead wires can be adhered to cold surfaces with varnish over a thin electrical insulator like cigarette paper. They can also be wound onto a bobbin that is firmly attached to the cold surface. Some sensor packages include a thermal anchor bobbin and wrapped lead wires to simplify thermal anchoring.

## 2.4.9 Thermal Radiation

Thermal (blackbody) radiation is one of the ways heat is transferred. Warm surfaces radiate heat to cold surfaces even through a vacuum. The difference in temperature between the surfaces is one thing that determines how much heat is transferred. Thermal radiation causes thermal gradients and reduces measurement accuracy. Many cooling systems include a radiation shield. The purpose of the shield is to surround the sample stage, sample, and sensor with a surface that is at or near their temperature to minimize radiation. The shield is exposed to the room temperature surface of the vacuum shroud on its outer surface, so some cooling power must be directed to the shield to keep it near the load temperature. If the cooling system does not include an integrated radiation shield (or one cannot be easily made), one alternative is to wrap several layers of super-insulation (aluminized mylar) loosely between the vacuum shroud and load. This reduces radiation transfer to the sample space.

## 2.5 Heater Selection and Installation

There is a variety of resistive heaters that can be used as the controlled heating source for temperature control. The mostly metal alloys like nichrome are usually wire or foil. Shapes and sizes vary to permit installation into different systems.

### 2.5.1 Heater Resistance and Power

Cryogenic cooling systems have a wide range of cooling power. The resistive heater must be able to provide sufficient heating power to warm the system. The Model 335 can provide up to 75 W of power from Output 1, up to 25 W of power from Output 2 in current mode, and up to 1 W of power from Output 2 in voltage mode. TABLE 2-2 provides the current and voltage limits, as well as the resulting maximum power for each output for the 25  $\Omega$  and 50  $\Omega$  settings, using nominal heater load values.

		25 $\Omega$ setting (25 $\Omega$ heater)	50 $\Omega$ setting (50 $\Omega$ heater)
Output 1	Current limit	1.41 A	1 A
	Voltage limit	50 V	50 V
	Max power	75 W	50 W
Output 2 (current mode)	Current limit	1 A	0.71 A
	Voltage limit	35.4 V	35.4 V
	Max power	25 W	25 W
Output 2 (voltage mode)	Current limit	100 mA	
	Voltage limit	$\pm 10$ V	
	Max power	1 W	

TABLE 2-2 Current and voltage limits with resulting max power

Even though the Model 335 heater outputs are current sources (Output 2 in current mode), they have a voltage limit called the compliance voltage. This compliance voltage also limits maximum power. So for heater values other than 25  $\Omega$  or 50  $\Omega$ , the maximum power must be calculated using the following equations:  $P = I^2R$  and  $P = V^2/R$ , where P is maximum power, I is max current, V is max voltage, and R is the heater resistance. The current and voltage limits are in place at the same time, so the smaller of the two computations gives the maximum power available to the heater.

When using Output 2 in voltage mode, the output behaves as a voltage source. In this mode the output is limited to  $\pm 10$  V, and  $\pm 100$  mA. As with the current source mode, both limits are in place at the same time, and the same equations can be used to determine the maximum power.

Example 1: A 20  $\Omega$  heater is connected to output 1, and the heater resistance setting is set to 25  $\Omega$ , which can provide up to 1.41 A of current, and up to 50 V.

Current limit	Voltage limit
$P = I^2R$	$P = V^2/R$
$P = (1.41 \text{ A})^2 \times (20 \Omega)$	$P = (50 \text{ V})^2/(20 \Omega)$
$P = 40 \text{ W}$	$P = 125 \text{ W}$

The power limit is the smaller of the two, or 40 W, limited by current.

Example 2: A 60  $\Omega$  heater is connected to Output 2 (in current mode), and the heater resistance setting is set to 50  $\Omega$ , which can provide up to 0.71 A of current, and up to 35.4 V.

Current limit	Voltage limit
$P = I^2R$	$P = V^2/R$
$P = (0.71 \text{ A})^2 \times (60 \Omega)$	$P = (35.4 \text{ V})^2/(60 \Omega)$
$P = 42.6 \text{ W}$	$P = 20.9 \text{ W}$

The power limit is the smaller of the two, or 20.9 W, limited by voltage.

Example 3: A 50  $\Omega$  heater is connected to Output 2 (in voltage mode). The maximum voltage for Output 2 in voltage mode is 10 V, and the maximum current is 100 mA.

Current limit	Voltage limit
$P = I^2R$	$P = V^2/R$
$P = (0.1 \text{ A})^2 \times (50 \Omega)$	$P = (10 \text{ V})^2/(50 \Omega)$
$P = 0.5 \text{ W}$	$P = 2 \text{ W}$

The power limit is the smaller of the two, or 0.5 W, limited by current.



**It is possible to choose a heater value that results in a maximum power greater than the power rating for either current source output, but doing so can cause the Model 335 to work improperly. In this situation the max user current setting should be used to limit the power. Refer to section 4.5.1.3.1 for details on using the max user current setting.**

The resistor chosen as a heater must be able to withstand the power being dissipated in it. Pre-packaged resistors have a power specification that is usually given for the resistor in free air. This power may need to be derated if used in a vacuum where convection cooling cannot take place and it is not adequately anchored to a cooled surface. The Model 335 has a current limit feature which allows you to specify the maximum output current for each heater output (section 4.5.1), which when set appropriately will help protect the heater from being overheated.

## 2.5.2 Heater Location

For best temperature measurement accuracy, position the heater so that temperature gradient across the sample is minimized. For best control, the heater should be in close thermal contact with the cooling power. Geometry of the load can make one or both of these difficult to achieve. That is why there are several heater shapes and sizes.

## 2.5.3 Heater Types

Resistive wire like nichrome is the most flexible type of heater available. The wire can be purchased with electrical insulation and has a predictable resistance per given length. This type of heater wire can be wrapped around a load to give balanced, even heating of the area. Similar to sensor lead wire, the entire length of the heater wire should be in good thermal contact with the load to allow for thermal transfer. Thermal anchoring also protects the wire from overheating and burning out.

Resistive heater wire is also wound into cartridge heaters. Cartridge heaters are more convenient, but are bulky and more difficult to place on small loads. A typical cartridge is 6.35 mm (0.25 in) in diameter and 25.4 mm (1 in) long. The cartridge should be snugly held in a hole in the load or clamped to a flat surface. Thermal anchoring for good thermal contact is again important.

Foil heaters are thin layers of resistive material adhered to, or screened onto, electrically insulating sheets. There are a variety of shapes and sizes. The proper size heater can evenly heat a flat surface or a round load. The entire active area should be in good thermal contact with the load, not only for maximum heating effect, but to keep spots in the heater from overheating and burning out.

## 2.5.4 Heater Wiring

For wiring inside a vacuum shroud, we recommend using 30 AWG copper wire for heater leads. Too much heat can transfer in when larger wire is used. Thermal anchoring, similar to that used for the sensor leads, should be included so that any heat transfer does not warm the load when the heater is not running. The lead wires should be twisted to minimize noise coupling between the heater and other leads in the system. When wiring outside the vacuum shroud, larger gauge copper cable can be used, and twisting is still recommended.

## 2.6 Consideration for Good Control

Most of the techniques discussed in section 2.4 and section 2.5 to improve cryogenic temperature accuracy apply to control as well. There is an obvious exception in sensor location. A compromise is suggested below in section 2.6.3.

### 2.6.1 Thermal Conductivity

Good thermal conductivity is important in any part of a cryogenic system that is intended to be at the same temperature. Most systems begin with materials that have good conductivity themselves, but as sensors, heaters, sample holders, etc., are added to an ever more crowded space, the junctions between parts are often overlooked. In order for control to work well, junctions between the elements of the control loop must be in close thermal contact and have good thermal conductivity. Gasket materials should always be used along with reasonable pressure (section 2.4.4 and section 2.4.5).

### 2.6.2 Thermal Lag

Poor thermal conductivity causes thermal gradients that reduce accuracy and also cause thermal lag that make it difficult for controllers to do their job. Thermal lag is the time it takes for a change in heating or cooling power to propagate through the load and get to the feedback sensor. Because the feedback sensor is the only thing that lets the controller know what is happening in the system, slow information to the sensor slows the response time. For example, if the temperature at the load drops slightly below the setpoint, the controller gradually increases heating power. If the feedback information is slow, the controller puts too much heat into the system before it is told to reduce heat. The excess heat causes a temperature overshoot, which degrades control stability. The best way to improve thermal lag is to pay close attention to thermal conductivity both in the parts used and in their junctions.

### 2.6.3 Two-Sensor Approach

There is a conflict between the best sensor location for measurement accuracy and the best sensor location for control. For measurement accuracy the sensor should be very near the sample being measured, which is away from the heating and cooling sources to reduce heat flow across the sample and thermal gradients. The best control stability is achieved when the feedback sensor is near both the heater and cooling source to reduce thermal lag. If both control stability and measurement accuracy are critical it may be necessary to use two sensors, one for each function. Many temperature controllers including the Model 335 have multiple sensor inputs for this reason.

### 2.6.4 Thermal Mass

Cryogenic designers understandably want to keep the thermal mass of the load as small as possible so the system can cool quickly and improve cycle time. Small mass can also have the advantage of reduced thermal gradients. Controlling a very small mass is difficult, because there is no buffer to absorb small changes in the system. Without buffering, small disturbances can very quickly create large temperature changes. In some systems it is necessary to add a small amount of thermal mass such as a copper block in order to improve control stability.

### 2.6.5 System Non-Linearity

Because of nonlinearities, a system controlling well at one temperature may not control well at another temperature. While nonlinearities exist in all temperature control systems, they are most evident at cryogenic temperatures. When the operating temperature changes the behavior of the control loop, the controller must be retuned. As an example, a thermal mass acts differently at different temperatures. The specific heat of the load material is a major factor in thermal mass. The specific heat of materials like copper change as much as three orders of magnitude when cooled from 100 K to 10 K. Changes in cooling power and sensor sensitivity are also sources of nonlinearity.

The cooling power of most cooling sources also changes with load temperature. This is very important when operating at temperatures near the highest or lowest temperature that a system can reach. Nonlinearities within a few degrees of these high and low temperatures make it very difficult to configure them for stable control. If difficulty is encountered, it is recommended to gain experience with the system at temperatures several degrees away from the limit and gradually approach it in small steps.

Keep an eye on temperature sensitivity. Sensitivity not only affects control stability, but it also contributes to the overall control system gain. The large changes in sensitivity that make some sensors so useful may make it necessary to retune the control loop more often.

## 2.7 PID Control

For closed-loop operation, the Model 335 temperature controller uses an algorithm called PID control. The control equation for the PID algorithm has three variable terms: proportional (P), integral (I), and derivative (D). See FIGURE 2-2. Changing these variables for best control of a system is called tuning. The PID equation in the Model 335 is:

$$\text{Heater output} = P \left[ e + I \int (e) dt + D \frac{de}{dt} \right]$$

where the error (e) is defined as: e = setpoint – feedback reading.

Proportional is discussed in section 2.7.1. Integral is discussed in section 2.7.2. Derivative is discussed in section 2.7.3. Finally, the manual heater output is discussed in section 2.7.4.

### 2.7.1 Proportional (P)

The proportional term, also called gain, must have a value greater than 0 for the control loop to operate. The value of the proportional term is multiplied by the error (e), which is defined as the difference between the setpoint and feedback temperatures, to generate the proportional contribution to the output:

$$\text{Output (P)} = P e$$

If proportional is acting alone, with no integral, there must always be an error or the output will go to 0. A great deal must be known about the load, sensor, and controller to compute a proportional setting (P). Most often, the proportional setting is determined by trial and error. The proportional setting is part of the overall control loop gain, as are the heater range and cooling power. The proportional setting needs to change if either of these change.

### 2.7.2 Integral (I)

The integral term, also called reset, looks at error over time to build the integral contribution to the output:

$$\text{Output (I)} = P I \int (e) dt$$

By adding the integral to proportional contributions, the error that is necessary in a proportional-only system can be eliminated. When the error is at 0, controlling at the setpoint, the output is held constant by the integral contribution. The integral setting (I) is more predictable than the gain setting. It is related to the dominant time constant of the load. As discussed in section 2.8.3, measuring this time constant allows a reasonable calculation of the integral setting. In the Model 335, the integral term is not set in seconds like some other systems. The integral setting can be derived by dividing 1000 by the integral seconds:  $I_{\text{setting}} = 1000 / I_{\text{seconds}}$ .

### 2.7.3 Derivative (D)

The derivative term, also called rate, acts on the change in error with time to make its contribution to the output:

$$\text{Output (D)} = P D \frac{de}{dt}$$

By reacting to a fast changing error signal the derivative can work to boost the output when the setpoint changes quickly, reducing the time it takes for temperature to reach the setpoint. It can also see the error decreasing rapidly when the temperature nears the setpoint and reduce the output for less overshoot. The derivative term can be useful in fast changing systems, but it is often turned off during steady state control because it reacts too strongly to small disturbances. The derivative setting (D) is related to the dominant time constant of the load similar to the I-setting and is therefore set relative to the I-setting when used.

### 2.7.4 Manual Output

The Model 335 has a control setting that is not a normal part of a PID control loop. Manual Output can be used for open loop control, meaning feedback is ignored and the heater output stays at the user's manual setting. This is a good way to put constant heating power into a load when needed. The Manual Output term can also be added to the PID output. Some users prefer to set a power near that necessary to control at a setpoint and let the closed loop make up the small difference. Manual Output is set in percent of full scale current or power for a given heater range (section 4.5.1.7.5).



**Manual Output should be set to 0% when not in use.**

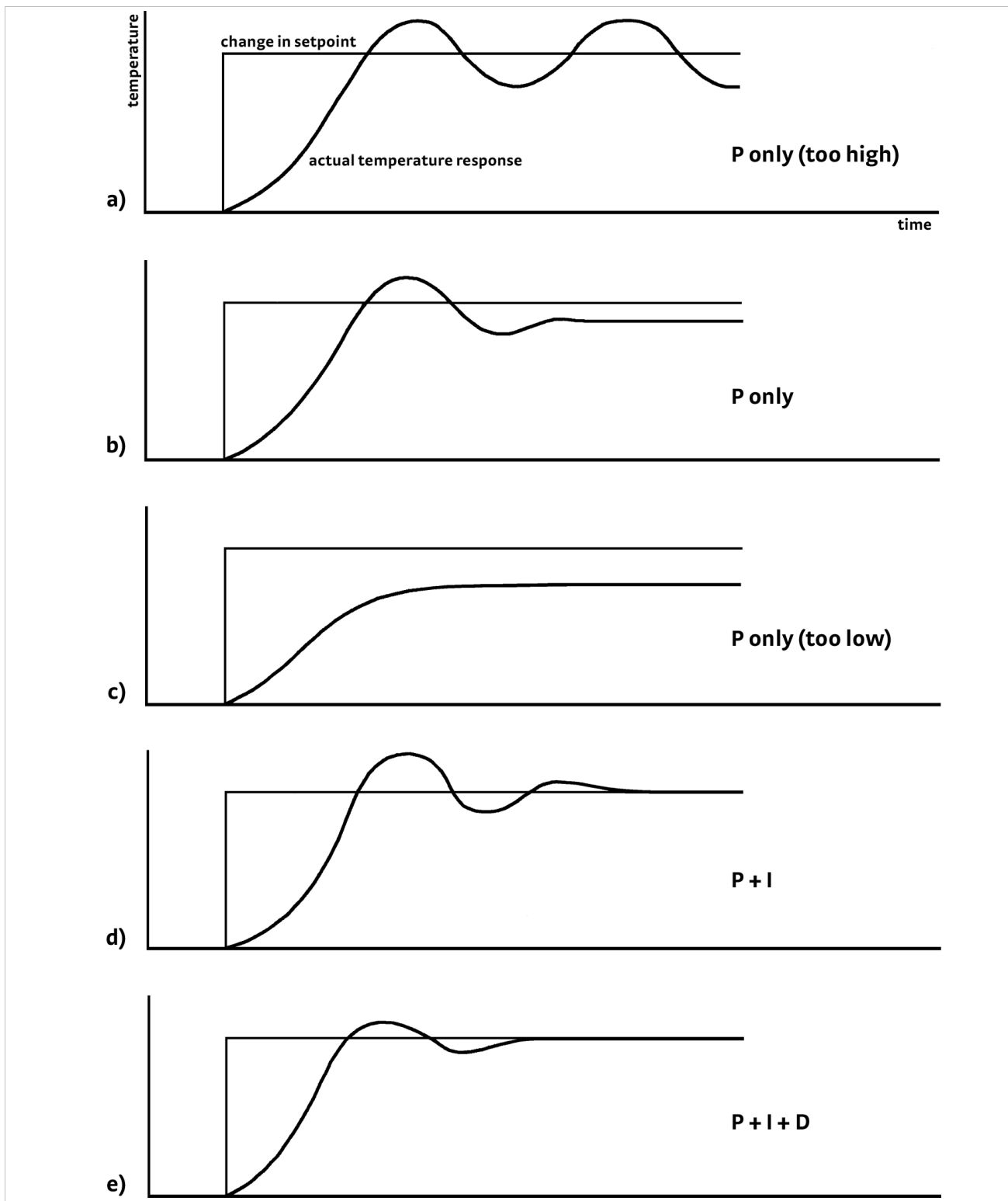

FIGURE 2-2 Examples of PID control



## 2.8 Manual Tuning

There has been a lot written about tuning closed loop control systems and specifically PID control loops. This section does not attempt to compete with control theory experts. It describes a few basic rules to help less experienced users get started. This technique will not solve every problem, but it has worked for many others in the field. This section assumes you have worked through the operation sections of this manual, you have a good temperature reading from the sensor chosen as a control sensor, and you are operating Loop 1. It is also a good idea to begin at the center of the temperature range of the cooling system (not close to its highest or lowest temperature). Autotune (section 2.9) is another good place to begin, and trial and error can be helpful as well.

### 2.8.1 Setting Heater Range

Setting an appropriate heater output range is an important first part of the tuning process. The heater range should allow enough heater power to comfortably overcome the cooling power of the cooling system. If the heater range will not provide enough power, the load will not be able to reach the setpoint temperature. Conversely, if the range is set too high, the load may have very large temperature changes that take a long time to settle out. Delicate loads can even be damaged by too much power.

Often there is little information on the cooling power of the cooling system at the desired setpoint. If this is the case, try the following: allow the load to cool completely with the heater off. Set Manual Output to 50% while in Open Loop control mode. Turn the heater to the lowest range and write down the temperature rise (if any). Select the next highest heater range and continue the process until the load warms up to room temperature. Do not leave the system unattended; the heater may have to be turned off manually to prevent overheating. If the load never reaches room temperature, some adjustment may be needed in heater resistance or load.

The list of heater range versus load temperature is a good reference for selecting the proper heater range. It is common for systems to require two or more heater ranges for good control over their full temperature. Lower heater ranges are normally needed for lower temperature. The Model 335 is of no use controlling at or below the temperature reached when the heater was off. Many systems can be tuned to control within a degree or two above that temperature.

### 2.8.2 Tuning Proportional

The proportional setting is so closely tied to heater range that they can be thought of as fine and course adjustments of the same setting. An appropriate heater range must be known before moving on to the proportional setting.

1. Allow the cooling system to cool and stabilize with the heater off.
2. Place the Model 335 in closed loop PID mode tuning.
3. Turn integral, derivative and manual output settings to 0.
4. Enter a setpoint several degrees above the cooling system's lowest temperature.
5. Enter a low proportional setting of approximately 5 or 10, and enter the appropriate heater range as described in section 2.8.1.
6. The load temperature should stabilize at a temperature below the setpoint. The heater display should show a value greater than 0% and less than 100%. If the load temperature does not stabilize below the setpoint, do one of the following:
  - a. If the load temperature and heater display reading swing rapidly, the proportional setting or possibly the heater range may be set too high. Reduce the proportional setting or the heater range, and go back to step 6.
  - b. If the load temperature and heater display reading change very slowly, a condition described as drift, it is an indication of a proportional setting that is too low. Increase the proportional setting and go back to step 6.

7. Gradually increase the proportional setting by doubling it each time. At each new setting, allow time for the temperature of the load to stabilize.
8. Repeat step 7 until you reach a setting in which the load temperature begins a sustained and predictable oscillation, rising and falling in a consistent period of time. See FIGURE 2-2(a).



**The goal is to find the proportional value in which the oscillation begins; do not turn the setting so high that temperature and heater output changes become extreme.**

9. If step 8 is achieved, complete steps 10 and 11; if step 8 is not achieved, skip to step 12.
10. Record the proportional setting and the amount of time it takes for the load to change from one temperature peak to the next. The time is called the oscillation period of the load. It helps describe the dominant time constant of the load, which is used in setting integral.
11. Reduce the proportional setting by half. The appropriate proportional setting is one half of the value required for sustained oscillation in step 8. See FIGURE 2-2(b). Continue to section 2.8.3.
12. There are a few systems that will stabilize and not oscillate with a very high proportional setting and a proper heater range setting. For these systems, setting a proportional setting of one half of the highest setting is a good starting point. Continue to section 2.8.3.

### 2.8.3 Tuning Integral

When the proportional setting is chosen and the integral is set to 0 (off), the Model 335 controls the load temperature below the setpoint. Setting the integral allows the Model 335 control algorithm to gradually eliminate the difference in temperature by integrating the error over time. See FIGURE 2-2(d). An integral setting that is too low causes the load to take too long to reach the setpoint. An integral setting that is too high creates instability and can cause the load temperature to oscillate.

1. Begin this part of the tuning process with the system controlling in proportional only mode.
2. Use the oscillation period of the load that was measured in section 2.8.2 in seconds. Divide 1000 by the oscillation period to get the integral setting.
3. Enter the integral setting into the Model 335 and watch the load temperature approach the setpoint.
4. Adjust the integral setting if necessary:
  - a. If the temperature does not stabilize and begins to oscillate around the setpoint, the integral setting is too high and should be reduced by one half.
  - b. If the temperature is stable but never reaches the setpoint, the integral setting is too low and should be doubled.
5. Verify the integral setting by making a few small (2 K to 5 K) changes in setpoint, and watch the load temperature react.

Trial and error can help improve the integral setting by optimizing for experimental needs. Faster integrals, for example, get to the setpoint more quickly at the expense of greater overshoot. In most systems, setpoint changes that raise the temperature act differently than changes that lower the temperature.

If it was not possible to measure the oscillation period of the load during proportional setting, start with an integral setting of 20. If the load becomes unstable, reduce the setting by half. If the load is stable, make a series of small, two to five degree changes in the setpoint and watch the load react. Continue to increase the integral setting until the desired response is achieved.

## 2.8.4 Tuning Derivative

If an experiment requires frequent changes in setpoint, derivative should be considered. See FIGURE 2-2(e). A derivative setting of 0, off, is recommended when the control system is seldom changed and data is taken when the load is at steady state.

The derivative setting is entered into the Model 335 as a percentage of the integral time constant. The setting range is 0% to 200% where 100% =  $\frac{1}{4} I$  seconds. Start with a setting of 50% to 100%.

Again, do not be afraid to make some small setpoint changes, halving or doubling this setting to watch the affect. Expect positive setpoint changes to react differently from negative setpoint changes.

## 2.9 Autotuning

Choosing appropriate PID control settings can be tedious. Systems can take several minutes to complete a setpoint change, making it difficult to watch the display for oscillation periods and signs of instability. With the Autotune feature, the Model 335 automates the tuning process by measuring system characteristics and, along with some assumptions about typical cryogenic systems, computes setting values for P, I, and D. Autotune works only with one control loop at a time and does not set the manual output or heater range. Setting an inappropriate heater range is potentially dangerous to some loads, so the Model 335 does not automate that step of the tuning process.

When Autotune is initiated, step changes are applied to the setpoint and the system response is observed to determine the best tuning parameters.

The Autotuning message appears when autotuning, and the display is configured to show the output of the control loop being tuned. The message blinks to indicate that the algorithm is still processing, and displays the current stage of the process, such as Stage 3 of 7. If the tuning process completes successfully, then the message is removed and the new PID parameters are configured. If the algorithm fails, the message stops blinking to indicate that it is no longer processing, and a failure message appears to indicate which stage of the process failed.

There are situations where Autotune is not the answer. The algorithm can be fooled when cooling systems are very fast, very slow, have a large thermal lag, or have a non-linear relationship between heater power and load temperature. If a load can reach a new setpoint in under 10 s (with an appropriate I-setting  $>500$ ), the cooling system is too fast for Autotuning. Systems with a very small thermal mass can be this fast. Adding mass is a solution, but is unappealing to users who need the speed for fast cycle times. Manual tuning is not difficult on these systems because new settings can be tested very quickly. Some systems are too slow for the Autotune algorithm. Any system that takes more than 15 min to stabilize at a new setpoint is too slow (with an appropriate I-setting  $<5$ ).

Thermal lag can be improved by using the sensor and heater installation techniques discussed in section 2.4 to section 2.6. Lag times up to a few seconds should be expected; much larger lags can be a problem. System nonlinearity is a problem for both Autotune and manual tuning. It is most commonly noticed when controlling near the maximum or minimum temperature of a temperature control system. It is not uncommon, however, for a user to buy a cryogenic cooling system specifically to operate near its minimum temperature. If this is the case, try to tune the system at five degrees above the minimum temperature and gradually reduce the setpoint, manually adjusting the control settings with each step. Any time the mechanical cooling action of a cryogenic refrigerator can be seen as periodic temperature fluctuations, the mass is too small or temperature too low to autotune.

## 2.10 Zone Tuning

Once the PID tuning parameters have been chosen for a given setpoint, the whole process may have to be done again for other setpoints significantly far away that have different tuning needs. Trying to remember when to use which set of tuning parameters can be difficult. The Model 335 has a Zone feature as one of its tuning modes that can help.

To use the Zone feature, you must determine the best tuning parameters for each part of the temperature range of interest. The parameters are then entered into the Model 335 where up to ten zones can be defined with different P, I, D, heater range, manual output, ramp rate, and control input settings. An upper boundary setting is assigned as the maximum temperature for that zone. The minimum temperature for a zone is the upper boundary for the previous zone, and 0 K is the starting point for the first zone. When Zone tuning is on, each time the setpoint changes, appropriate control parameters are chosen automatically. Zone tuning works best when used in conjunction with setpoint ramping (section 4.5.1.7.7).

Control parameters can be determined manually or by using the Autotune feature. Autotune is a good way to determine a set of tuning parameters for the control system that can then be entered as zones (section 2.9).

## 2.11 Thermoelectric Devices

A thermoelectric device, sometimes referred to as a Peltier device, or a solid state heat pump, is a device that takes advantage of the Peltier effect. When a DC current is applied to the device, heat is transferred from one side of the device to the other. Heat can be transferred in either direction by reversing the polarity of the current. Thermoelectric devices are well suited for controlling temperatures near room temperature since they have both heating and cooling capabilities. Since thermoelectric devices are solid state, they are free of the mechanical vibrations associated with mechanical coolers. Some thermoelectric coolers, in a stacked configuration, are capable of cooling devices down to cryogenic temperatures (about 100 K). These are often used to cool and maintain the temperatures of charge-coupled device (CCD) sensors.

Since thermoelectric devices are capable of both heating and cooling, they require a controller that has a bipolar output to take full advantage of this. The Model 335 can be configured for bipolar control on Output 2 in voltage mode. Closed loop PID control works the same in bipolar mode as it does in unipolar mode except that the output can go negative instead of stopping at zero. Refer to section 5.4 to setup Output 2 in bipolar mode.

The Model 335 cannot drive a thermoelectric device directly. Most thermoelectric devices require high current (approximately 3 A) and low voltage (typically < 10 V). Output 2 is capable of  $\pm 10$  V and  $\pm 100$  mA. An external power amplifier is necessary to boost the power up to a level that will effectively control the thermoelectric device. Refer to section 3.7.5 for more information on using an external power amplifier with Output 2.

# Chapter 3: Installation

## 3.1 General

This chapter provides general installation instructions for the Model 335 temperature controller. Please read this entire chapter before installing the instrument and powering it on to ensure the best possible performance and maintain operator safety. For instrument operating instructions refer to Chapter 4 and Chapter 5. For computer interface installation and operation refer to Chapter 6.

## 3.2 Inspection and Unpacking

Inspect shipping containers for external damage before opening them. Photograph any container that has significant damage before opening it. Inspect all items for both visible and hidden damage that occurred during shipment. If there is visible damage to the contents of the container, contact the shipping company and Lake Shore immediately, preferably within five days of receipt of goods, for instructions on how to file a proper insurance claim. Lake Shore products are insured against damage during shipment, but a timely claim must be filed before Lake Shore will take further action. Procedures vary slightly with shipping companies. Keep all damaged shipping materials and contents until instructed to either return or discard them.

Open the shipping container and keep the container and shipping materials until all contents have been accounted for. Check off each item on the packing list as it is unpacked. Instruments themselves may be shipped as several parts. The items included with the Model 335 are listed below. Contact Lake Shore immediately if there is a shortage of parts or accessories. Lake Shore is not responsible for any missing items if they have not been notified within 60 days of shipment.

If the instrument must be returned for recalibration, replacement or repair, a return authorization (RMA) number must be obtained from a Lake Shore representative before it is returned. Refer to section 8.14.2 for the Lake Shore RMA procedure.

Items Included with the Model 335 temperature controller:

- 1 Model 335 instrument
- 1 Model 335 user manual
- 2 sensor input mating connectors, 6-pin DIN (G-106-233)
- 2 heater output connectors, dual banana, for heater Outputs 1 and 2
- 1 terminal block mating connector, 8-pin terminal block, for Output 2 in voltage mode, and relays 1 and 2
- 1 line power cord
- 1 line power cord for alternative voltage\*

\* Included only when purchased with VAC-120-ALL power option.

### 3.3 Rear Panel Definition

This section provides a description of the Model 335 rear panel connections. The rear panel consists of the Input A and B sensor input connectors (#1 in FIGURE 3-1), Output 2 voltage output and relays 1 and 2 terminal block connector (2), USB B-type connector (3), IEEE-488 interface connector (4), line input assembly (5), Output 1 and 2 heater output connectors (6 and 7), and the thermocouple option inputs (8). Refer to section 8.10 for rear panel connector pin-out details.



**Always turn off the instrument before making any rear panel connections. This is especially critical when making sensor to instrument connections.**

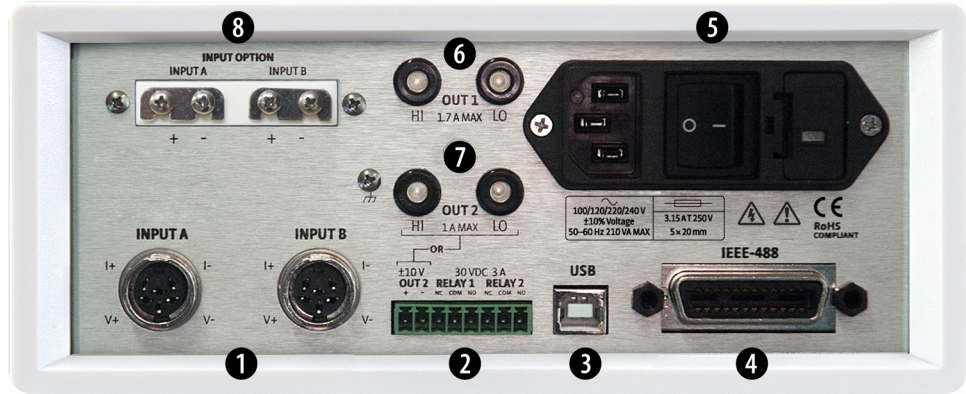

FIGURE 3-1 Model 335 rear panel

### 3.4 Line Input Assembly

This section describes how to properly connect the Model 335 to line power. Please follow these instructions carefully to ensure proper operation of the instrument and the safety of operators.

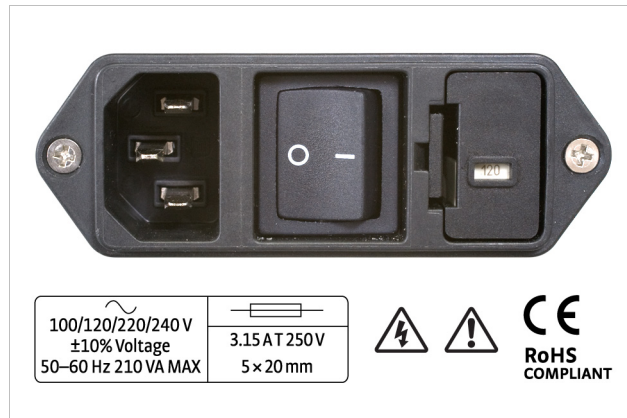

FIGURE 3-2 Line input assembly

#### 3.4.1 Line Voltage

The Model 335 has four different AC line voltage configurations so that it can be operated from line power anywhere in the world. The nominal voltage and voltage range of each configuration is shown below. (The recommended setting for 230 V operation is 240 V.)

Nominal	Minimum	Maximum
100 V	90 V	110 V
120 V	108 V	132 V
220 V	198 V	242 V
240 V	216 V	264 V

TABLE 3-1 Line voltage



## ⚠ CAUTION

AC line voltage is set at Lake Shore, but it is good to verify that the AC line voltage indicator in the fuse drawer window is appropriate before turning the instrument on. The instrument may be damaged if turned on with the wrong voltage selected. Also remove and verify that the proper fuse is installed before plugging in and turning on the instrument. Refer to section 8.5 for instructions on changing the line voltage configuration.

### 3.4.2 Line Fuse and Fuse Holder

The line fuse is an important safety feature of the Model 335. If a fuse ever fails, it is important to replace it with the value and type indicated on the rear panel for the line voltage setting. The letter T on the fuse rating indicates that the instrument requires a time-delay or slow-blow fuse. Fuse values should be verified any time line voltage configuration is changed. Refer to section 8.6 for instructions for changing and verifying a line fuse.

### 3.4.3 Power Cord

The Model 335 includes a 3-conductor power cord that mates with the IEC 320-C14 line cord receptacle. Line voltage is present on the two outside conductors, and the center conductor is a safety ground. The safety ground attaches to the instrument chassis and protects the user in case of a component failure. A CE approved power cord is included with instruments shipped to Europe; a domestic power cord is included with all other instruments (unless otherwise specified when ordered).

## ⚠ WARNING

**Always plug the power cord into a properly grounded receptacle to ensure safe instrument operation.**

The delicate nature of measurements being taken with this instrument may necessitate additional grounding including ground strapping of the instrument chassis. In these cases, the operator's safety should remain the highest priority and low impedance from the instrument chassis to safety ground should always be maintained.

### 3.4.4 Power Switch

The power switch is part of the line input assembly on the rear panel of the Model 335, and it turns line power to the instrument on and off. When the circle is depressed, power is off. When the line is depressed, power is on.

## 3.5 Diode/Resistor Sensor Inputs

This section details how to connect diode and resistor sensors to the Model 335 inputs. Refer to section 4.4 to configure the inputs. Refer to section 3.6 for a description of the optional thermocouple input.

### 3.5.1 Sensor Input Connector and Pinout

The input connectors are 6-pin DIN 45322 sockets. The sensor connector pins are defined in FIGURE 3-3 and TABLE 3-2. Two mating connectors (6-pin DIN plugs) are included in the connector kit shipped with the instrument. These are common connectors, so additional mating connectors can be purchased from local electronics suppliers. They can also be ordered from Lake Shore as G-106-233.

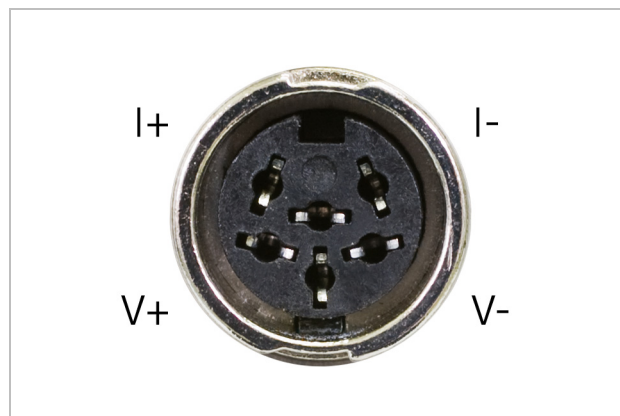

FIGURE 3-3 Sensor input connector



Pin	Symbol	Description
1	I-	-Current
2	V-	-Voltage
3	None	Shield
4	V+	+Voltage
5	I+	+Current
6	None	Shield

TABLE 3-2 Diode/resistor input connector details

### 3.5.2 Sensor Lead Cable

The sensor lead cable used outside the cooling system can be much different from what is used inside. Between the instrument and vacuum shroud, heat leak is not a concern. In this case, cabling should be chosen to minimize error and noise pick up. Larger conductor, 22 AWG to 28 AWG stranded copper wire is recommended because it has low resistance yet remains flexible when several wires are bundled in a cable. The arrangement of wires in a cable is also important. For best results, voltage leads, V+ and V- should be twisted together and current leads I+ and I- should be twisted together. The twisted pairs of voltage and current leads should then be covered with a braided or foil shield that is connected to the shield pin of the instrument. This type of cable is available through local electronics suppliers. Instrument specifications are given assuming 3 m (10 ft) of sensor cable. Longer cables, 30 m (100 ft) or more, can be used, but environmental conditions may degrade accuracy and noise specifications. Refer to section 2.4.6 for information about wiring inside the cryostat.

### 3.5.3 Grounding and Shielding Sensor Leads

The sensor inputs are isolated from earth ground to reduce the amount of earth ground referenced noise that is present on the measurement leads. Connecting sensor leads to earth ground on the chassis of the instrument or in the cooling system will defeat that isolation. Grounding leads on more than one sensor prevents the sensor excitation current sources from operating.

Shielding the sensor lead cable is important to keep external noise from entering the measurement. A shield is most effective when it is near the measurement potential so the Model 335 offers a shield at measurement common. The shield of the sensor cable should be connected to the shield pin of the input connector. The shields should not be connected to earth ground on the instrument chassis. One shield should be connected to the cryostat's ground as long as it is near earth ground. Connecting at more than one point will cause a ground loop, which adds noise to the measurement.



**The shells of the input connectors are at the same potential as the shield pin on the Model 335. Some older Lake Shore temperature controllers (such as the Model 331 and Model 332) are not configured this way.**

### 3.5.4 Sensor Polarity

Lake Shore sensors are shipped with instructions that indicate which sensor leads are which. It is important to follow these instructions for plus and minus leads (polarity) as well as voltage and current when applicable. Diode sensors do not operate in the wrong polarity. They look like an open circuit to the instrument. 2-lead resistors can operate with any lead arrangement and the sensor instructions may not specify. 4-lead resistors can be more dependent on lead arrangement. Follow any specified lead assignment for 4-lead resistors. Mixing leads could give a reading that appears correct but is not the most accurate.

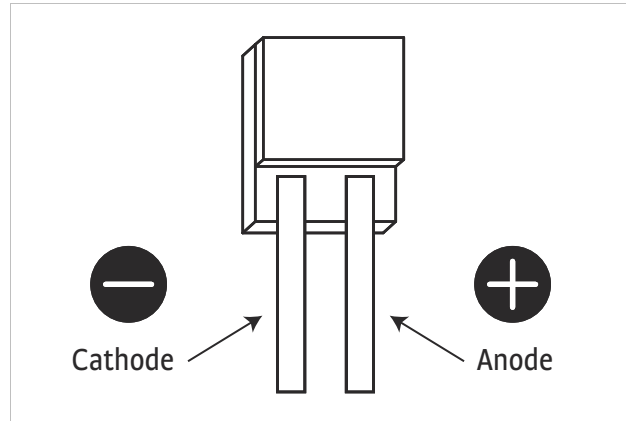

FIGURE 3-4 DT-670-SD Diode sensor leads

### 3.5.5 Four-Lead Sensor Measurement

All sensors, including both 2-lead and 4-lead can be measured with a 4-lead technique. The purpose of a 4-lead measurement is to eliminate the effect of lead resistance on the measurement. If it is not taken out, lead resistance is a direct error when measuring a sensor.

In a 4-lead measurement, current leads and voltage leads are run separately up to the sensor. With separate leads there is little current in the voltage leads, so their resistance does not enter into the measurement. Resistance in the current leads will not change the measurement as long as the voltage compliance of the current source is not reached. When 2-lead sensors are used in 4-lead measurements, the short leads on the sensor have an insignificant resistance.

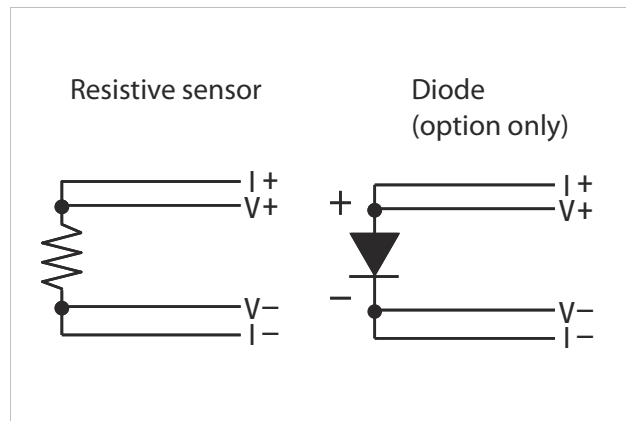

FIGURE 3-5 4-lead measurement

### 3.5.6 Two-Lead Sensor Measurement

There are times when crowding in a cryogenic system forces users to read sensors in a 2-lead configuration because there are not enough feedthroughs or room for lead wires. If this is the case, plus voltage to plus current and minus voltage to minus current leads are attached at the back of the instrument or at the vacuum feedthrough.

The error in a resistive measurement is the resistance of the lead wire run with current and voltage together. If the leads contribute 2  $\Omega$  or 3  $\Omega$  to a 10 k $\Omega$  reading, the error can probably be tolerated. When measuring voltage for diode sensors, the error in voltage can be calculated as the lead resistance times the current, typically 10  $\mu\text{A}$ .

For example: a 10  $\Omega$  lead resistance times 10  $\mu\text{A}$  results in a 0.1 mV error in voltage. Given the sensitivity of a silicon diode at 4.2 K, the error in temperature would be close to 3 mK. At 77 K the sensitivity of a silicon diode is lower so the error would be close to 50 mK. Again, this may not be a problem for every user.

Connectors are also a big source of error when making 2-lead measurements. Connector contact resistance is unpredictable and changes with time and temperature. Minimize interconnections when making 2-lead measurements. Refer to FIGURE 3-6 for an image of a 2-lead sensor measurement.

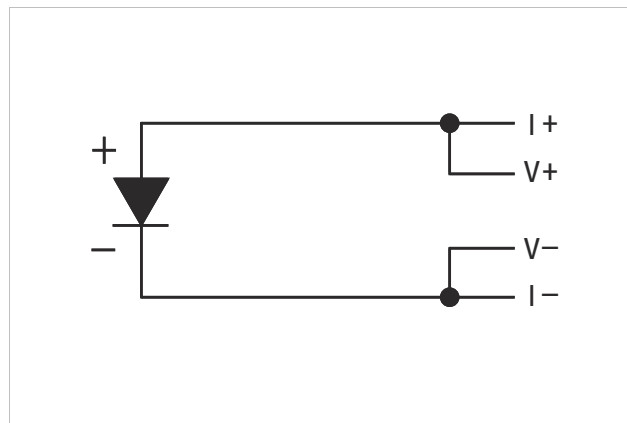

FIGURE 3-6 2-lead sensor measurement

### 3.5.7 Lowering Measurement Noise

Good instrument hardware setup technique is one of the least expensive ways to reduce measurement noise. The suggestions fall into two categories: (1) do not let noise from the outside enter into the measurement, and (2) let the instrument isolation and other hardware features work to their best advantage. Here are some further suggestions:

- Use 4-lead measurement whenever possible
- Do not connect sensor leads to chassis or earth ground
- Use twisted shielded cable outside the cooling system
- Attach the shield pin on the sensor connector to the cable shield
- Do not attach more than one cable shield at the other end of the cable
- Run different inputs and outputs in their own shielded cable
- Use twisted wire inside the cooling system
- Use twisted wire for heater leads
- Use a grounded receptacle for the instrument power cord
- Consider ground strapping the instrument chassis to other instruments or computers

## 3.6 Thermocouple Sensor Inputs (Thermocouple Model 3060)



**Do not leave thermocouple inputs unconnected. Short inputs when they are not in use.**

### 3.6.1 Sensor Input Terminals

Sensor connection is important when using thermocouples because the measured signal is small. Many measurement errors can be avoided with proper sensor installation. The ceramic terminal block has two thermocouple inputs and each input has two screw terminals; one positive, one negative (FIGURE 3-7).

Attach sensor leads to the screws on the ceramic terminal block. Remove all insulation from the ends of the thermocouple wires then tighten the screws down onto the thermocouple wires. Keep the ceramic terminal blocks away from heat sources including sunlight, and shield them from fans or room drafts.

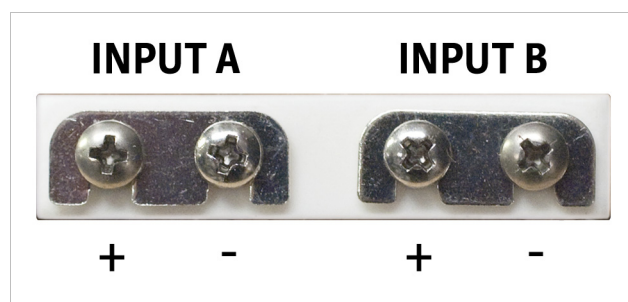

FIGURE 3-7 Thermocouple input definition and common connector polarities (inputs shown shorted)

### 3.6.2 Thermocouple Installation

Thermocouples are commonly used in high-temperature applications. Cryogenic use of thermocouples offers some unique challenges. A general sensor installation guideline is provided in section 2.4. Consider the following when using thermocouples at low temperatures:

- Thermocouple wire is generally more thermally conductive than other sensor lead wire. Smaller gauge wire and more thermal anchoring may be needed to prevent leads from heating the sample.
- Attaching lead wires and passing them through vacuum tight connectors is often necessary in cryogenic systems. Remember, the thermocouple wire is the sensor; any time it joins or contacts other metal, there is potential for error.
- Temperature verification and calibration of room temperature compensation is difficult after the sensor is installed. When possible, keep a piece of scrap wire from each installation for future use.
- Thermocouples can be spot-welded to the cryostat for good thermal anchoring as long as the cryostat has a potential close to earth ground.

### 3.6.3 Grounding and Shielding

Care must be taken to minimize the amount of noise contributed by ground loops, when grounding thermocouple inputs. For lowest measurement noise, do not ground thermocouple sensors. The instrument operates with slightly more noise if one of the thermocouples is grounded. Be sure to minimize loop area when grounding both thermocouples. The instrument does not offer a shield connection on the terminal block. Twisting the thermocouple wires helps reject noise. If shielding is necessary, extend the shield from the oven or cryostat to cover the thermocouple wire, but do not attach the shield to the instrument.

## 3.7 Heater Output Setup

The following section covers the heater wiring from the vacuum shroud to the instrument for both heater outputs. Specifications are detailed in section 1.3. For help on choosing and installing an appropriate resistive heater, refer to section 2.5.

### 3.7.1 Heater Output Description

Output 1 and Output 2 in current mode are traditional control outputs for a cryogenic temperature controller. Both are variable DC current sources with software settable ranges and limits. Both are configurable for optimization using either a 25  $\Omega$  or a 50  $\Omega$  heater resistance. At the 50  $\Omega$  setting, Output 1 is limited to 1 A (50 W), and Output 2 is limited to 0.707 A (25 W). At the 25  $\Omega$  setting, the maximum heater output current is 1.732 A (75 W) for Output 1 and 1 A (25 W) for Output 2 (if Output 1 is set to 50 W or less).

The compliance voltage of Output 1 is 50 V minimum, but can reach as high as 58 V if the heater resistance is higher than the nominal setting, and the compliance voltage of Output 2 is 35.4 V minimum, but can reach as high as 41 V if the heater resistance is higher than the nominal setting. Heater power is applied in one of three ranges: high, med, or low. Each range is one decade lower in power. Refer to TABLE 4-11 for maximum current and power ratings into different heater resistance.

### 3.7.2 Heater Output Connectors

Dual banana jacks on the rear panel of the instrument are used for connecting wires to the heater outputs. Two standard dual banana plug mating connectors are included in the connector kit shipped with the instrument. This is a common jack and additional mating connectors can be purchased from local electronic suppliers, or from Lake Shore as P/N 106-009. The heater is connected between the HI and LO terminals.



FIGURE 3-8 Rear panel showing heater output connectors

### 3.7.3 Heater Output Wiring

Heater output current is what determines the size (gauge) of wire needed to connect the heater. The maximum current that can be sourced from heater Output 1 is 1.732 A. When less current is needed to power a cooling system, it can be limited with range settings.

When setting up a temperature control system, the lead wire for the heater must be capable of carrying a continuous current that is greater than the maximum current. Wire manufacturers recommend 26 AWG or larger wire to carry 1.732 A of current, but there is little advantage in using wire smaller than 20 AWG to 22 AWG outside the cryostat. Inside the cryostat, smaller gauge wire is often desirable.

It is recommended to use twisted heater leads. Large changes in heater current can induce noise in measurement leads and twisting reduces the effect. It is also recommended to run heater leads in a separate cable from the measurement leads to further reduce interaction.

There is a chassis ground point at the rear panel of the instrument for shielding the heater cable if necessary. The cable shield can be tied to this point using a 3.18 mm (#4) spade terminal, or ring connector. The shield should not be connected at the opposite end of the cable and should never be tied to the heater output leads.

For best noise performance, do not connect the resistive heater or its leads to ground. Also avoid connecting heater leads to sensor leads or any other instrument inputs or outputs.

### 3.7.4 Heater Output Noise

The heater output circuitry in the Model 335 is capable of sourcing 75 W of power. This type of circuitry can generate some electrical noise. The Model 335 was designed to generate as little noise as possible, but even noise that is a small percentage of the output voltage or current can be too much when sensitive measurements are being made nearby. If the Model 335 heater leads are too noisy and the above wiring techniques do not help, Lake Shore offers the Model 3003 heater output conditioner to help reduce noise (section 7.7).

### 3.7.5 Powering Output 2 Using an External Power Supply

Output 2 in voltage mode can be used to program an external power supply, which in turn powers the heater. This can be useful if more than 75 W is needed for either closed loop PID control, warm up control, or open loop operation. This section describes choosing and installing an external supply. Section 5.5 describes operation of the warm up supply mode.

#### 3.7.5.1 Choosing a Power Supply

- *Voltage programmable*: the power supply must be voltage programmable so that Output 2 in voltage mode can control it. Ideally the supply's programming input should have a range of 0 V to 10 V that corresponds to 0 V to 10 V range of the control output. This guarantees that 0% to 100% of the control output scales to 0% to 100% power out of the supply. Supplies with different programming input ranges can be used as described in section 3.7.5.4.

### ⚠ CAUTION

**Be aware that if the input voltage is not within the range of the power supply, damage may result.**

- *DC output capable*: the power supply must be capable of continuous DC output. Most commercial audio amplifiers are not suitable because they are AC coupled and cannot provide a DC output.
- *Output type*: most available voltage programmable power supplies are configured for voltage output. This is different than Outputs 1 and 2 (current mode) on the Model 335, which are configured for current output. The differences between the two are not significant when used in warm up mode.
- *Output voltage*: Lake Shore recommends supplies with a working output voltage between 10 V and 50 V. Voltage higher than 50 V poses a shock hazard and should only be used if operator safety can be assured by the installer. Voltage lower than 10 V becomes impractical because the current necessary to provide any meaningful power is too high for most cryogenic wiring.
- *Output power*: there is no limit to the maximum power of the supply. Typical warm up applications normally range between 25 W and 200 W.

### 3.7.5.2 Power Supply Setup

Follow all operation and safety instruction in the power supply manual during setup. Please consider the following suggestions for protecting the power supply and heater load.

- Short circuits are common in cryogenic lead wiring. If the power supply does not specify that it is short circuit protected, the power output should be wired with a fuse in series to prevent damage.
- Unipolar power supplies are designed to use a positive programming voltage and some can be damaged if the programming voltage is negative. Be careful when wiring the system to maintain the correct polarity. Never set the control output of the Model 335 to bipolar mode when using a unipolar power supply.
- Some power supplies can be damaged if there is a programming voltage present at their input when they are turned off. This can happen if the Model 335 and power supply use a different source of line power or are turned on and off individually. It can be avoided if the two instruments share a switched power strip.
- The heater and wiring in the system must be rated for both the maximum current and maximum voltage provided by the power supply. The Model 335 can be set to warm up using less than full power if the load will not tolerate the full power of the supply.

### 3.7.5.3 Connecting to the Model 335

The voltage programming cable attaches to the removable terminal block on the rear panel of the Model 335 (FIGURE 3-9). Output number and polarity of the output leads are labelled. The negative (-) terminals are connected internally to the instrument chassis to provide a ground reference.

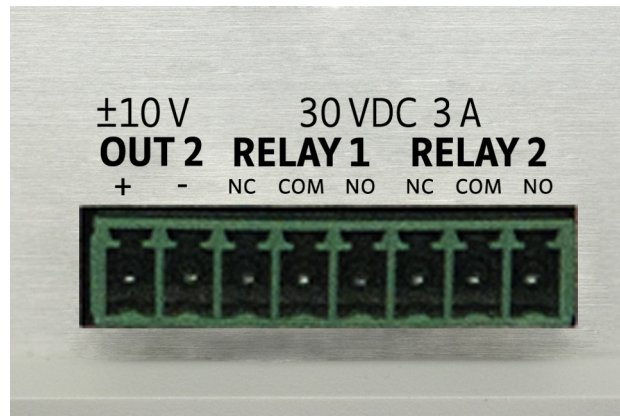

FIGURE 3-9 *Output terminal block*

In the most basic configuration, a two-conductor cable connects directly from the output terminals to the power supply programming input. Copper wire size 20 AWG to 26 AWG is recommended.



#### 3.7.5.4 Programming Voltages Under 10 V

A voltage divider (FIGURE 3-10) can be used to reduce the control output voltage if the programming input of the power supply has a range of less than 0 V to 10 V to ensure full output resolution, and protection against overloading the external supply programming inputs. The output voltage is proportional to the ratio of resistors R1 to R2:  $V_{\text{out}} = 10 \text{ V} \times R1/(R1+R2)$ . It is also important to keep the sum of  $R1 + R2 > 1000 \Omega$  or the Model 335 output may not reach the output voltage setting due to internal overload protection. For a programming input range of 0 V to 5 V, recommended values are:  $R1 = R2 = 2000 \Omega$ . For a programming input range of 0 V to 1 V, recommended values are:  $R1 = 500 \Omega$ ,  $R2 = 4500 \Omega$ . Exact resistor value, type and tolerance are generally not important for this application.

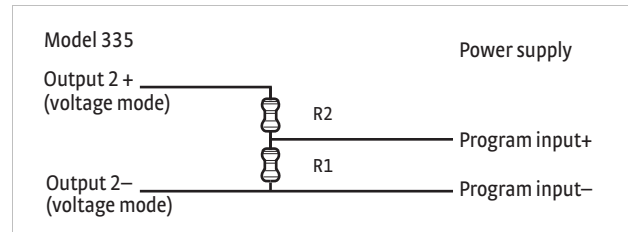

FIGURE 3-10 Voltage divider circuit for Output 2 (voltage mode)



# Chapter 4: Operation

## 4.1 General

This chapter provides instructions for the general operating features of the Model 335 temperature controller. Advanced operation is in Chapter 5. Computer interface instructions are in Chapter 6.

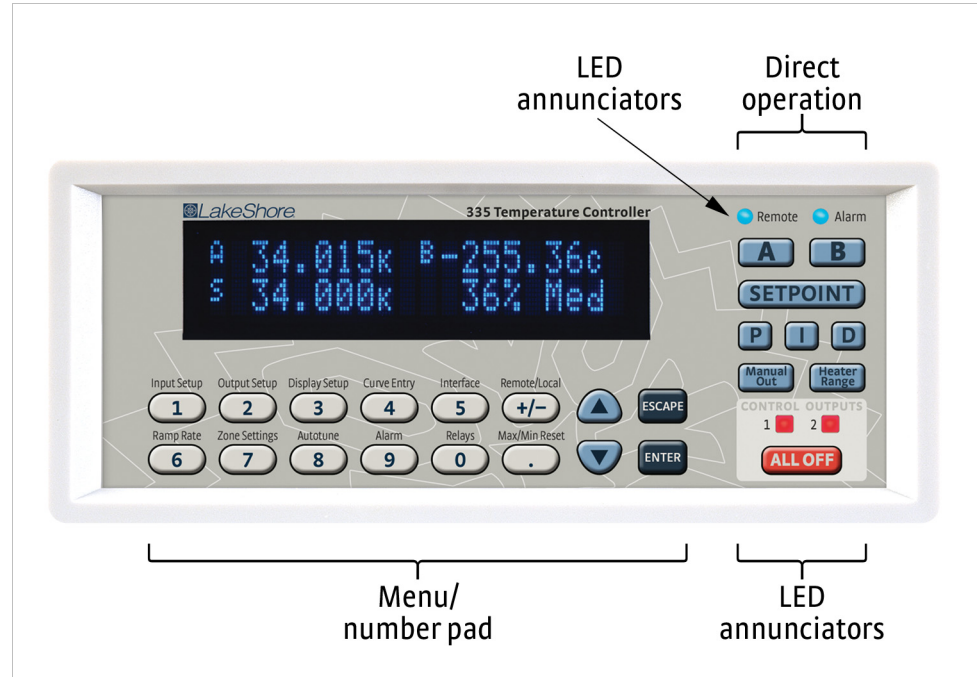

FIGURE 4-1 Model 335 front panel

### 4.1.1 Understanding Menu Navigation

This section is intended to be a quick guide through the necessary key presses to arrive at and set the desired features. Each feature that is discussed in this chapter will include a menu navigation section. See FIGURE 4-2 and TABLE 4-1 for an explanation of the conventions used in the menu navigation.

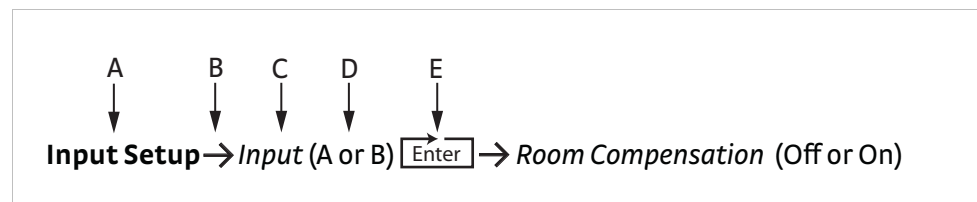

FIGURE 4-2 Menu navigation example

Item	Convention	Explanation
A	<b>Bold</b>	Typically, the first word in the menu navigation is in bold type, which indicates the first key you will need to press.
B	→	The arrow indicates that the screen is advancing to the next screen. In the menu navigation, the item that follows the arrow is the next item you would see on the screen or the next action that you will need to perform.
C	<i>Italic type</i>	Often, the words that follow the arrow are in italic type. The italic type indicate that there is a setting that needs to be selected.
D	(Parentheses)	The items that follow the italicized word and which are in parentheses, are the available selections to which you can set the desired feature.
E	ENTER	This symbol indicates that you will need to press Enter until you arrive at the desired feature.

TABLE 4-1 Menu navigation key

## 4.2 Front Panel Description

This section provides a description of the front panel controls and indicators for the Model 335.

### 4.2.1 Keypad Definitions

The keypad is divided into two sections. The direct operation section includes all keys to the right of the display, and the menu/number pad section includes the standard 12 number-pad keys and the **Up**, **Down**, **Escape**, and **Enter** keys (FIGURE 4-2). The direct operation keys provide one touch access to the most often used functions of the Model 335. The number pad keys are dual function keys. If the instrument is in the number entry mode, the keys are used to enter numbers. If it is in normal operating mode, the number keys provide menu entry points. An abbreviated description of each key is provided in the next sections. A more detailed description of each function is provided in section 4.3 to section 4.5.

#### 4.2.1.1 Direct Operation Keys

Key	Function	Refer to section:
<b>A and B</b>	Press these keys for quick access to information for the associated sensor input including the sensor name, control loop information, sensor reading and Min/Max.	4.3.1.3
<b>Setpoint</b>	Press this key to enter the control setpoint.	4.5.1.7.6
<b>Proportional (P)</b>	Press this key to manually adjust the Proportional control parameter.	4.5.1.7.2
<b>Integral (I)</b>	Press this key to manually adjust the Integral control parameter.	4.5.1.7.3
<b>Derivative (D)</b>	Press this key to manually adjust the Derivative control parameter.	4.5.1.7.4
<b>Heater Range</b>	For current source output, press this key to select a High, Med, or Low heater range. For voltage source output (Output 2, voltage mode), press this key to select Output On/Off (except when in Monitor Out mode).	4.5.1.7.8
<b>Manual Out</b>	Press this key to adjust the Manual Output setting of the currently displayed output, if applicable.	4.5.1.7.5
<b>All Off</b>	Press this key to set the range for all outputs to Off (not applicable for Monitor Out mode).	4.5.1.7.9

TABLE 4-2 *Direct operation keys*

#### 4.2.1.2 Menu/Number Pad Keys

Key	Function	Refer to section
<b>Input setup</b>	Press this key to configure features related to the inputs.	4.4 for sensor input setup; 4.4.7 for curve selection
<b>Output setup</b>	Press this key to configure features related to the outputs, including configuration of control loops.	4.5
<b>Display setup</b>	Press this key to configure the display.	4.3
<b>Max/Min reset</b>	Press this key to reset the maximum and minimum readings for both inputs.	4.4.12
<b>Curve entry</b>	Press this key to view, edit, copy, and erase temperature curves, and to generate SoftCal curves.	5.9
<b>Zone settings</b>	Press this key to enter user-specified control parameters for up to ten temperature zones.	5.3
<b>Autotune</b>	Press this key to configure and execute the Autotune algorithm.	5.2
<b>Remote/local</b>	Press this key to toggle the IEEE-488 Remote mode.	4.6.2.1
<b>Interface</b>	Press this key to configure the USB, and IEEE-488 interfaces.	4.6.1 for USB; 4.6.2 for IEEE-488
<b>Relays</b>	Press this key to configure the two rear-panel relays.	5.7.2
<b>Alarm</b>	Press this key to configure the Alarm feature.	5.7.1
<b>▲</b>	Press this key to navigate menus, and to select parameters.	N/A
<b>▼</b>	Press this key to navigate menus, and to select parameters.	N/A
<b>Escape (exit menu)</b>	Press this key to cancel a number entry or exit the menu. Press and hold for 3 s to reset instrument parameters to factory default values.	N/A
<b>Enter</b>	Press this key to accept a number entry, or a parameter selection. Press and hold for 3 s to lock or unlock the keypad.	N/A
<b>0–9, +/–, .</b>	Press these keys to enter numeric data. This includes a key to toggle plus (+) or minus (–), and a key for entry of a decimal point.	4.2.3
<b>Ramp rate</b>	Press this key to configure the ramp rate parameter for the displayed control loop.	4.5.1.7.7

TABLE 4-3 *Menu/number pad keys*

## 4.2.2 Annunciators

*LED annunciators:* two blue and two red LED annunciators are included to provide visual feedback of the following operation.

LED	Function	Refer to section
<b>Remote</b>	The Remote LED is on steady when instrument is in Remote mode (may be controlled via the Remote/Local key). If the LED is not illuminated, the instrument is in Local mode.	4.6.2.1
<b>Alarm</b>	The Alarm LED is on steady when the alarm feature for any sensor input is turned on and the input's Visual parameter is set to On. It blinks when any input sensor alarms are in the alarming state and the alarming input's Visual parameter is set to On.	5.7
<b>Control outputs</b>	The control output LED is on steady when the corresponding output is in the On state (does not apply to Monitor Out mode). It is Off when the corresponding output is in the Off state, or is set to Monitor Out mode.	4.5.1.6

TABLE 4-4 *LED annunciators*

*Display annunciators:* include symbols for sensor inputs and their respective temperatures and units.

Annunciator	Function
<b>A</b>	Sensor input A
<b>B</b>	Sensor input B
<b>K</b>	Temperature in kelvin
<b>°C</b>	Temperature in degrees Celsius
<b>V</b>	Sensor units of volts
<b>Ω</b>	Sensor units of ohms
<b>kΩ</b>	Sensor units of kilohms
<b>m v</b>	Sensor units of millivolts

TABLE 4-5 *Display annunciators*

## 4.2.3 General Keypad Operation

There are five basic keypad operations: direct operation, menu navigation, Number Entry, Alpha-Numeric Entry and setting selection.

- *Direct operation:* the key function occurs as soon as the key is pressed; these include the **Setpoint**, **P**, **I**, **D**, **Manual Out**, **Heater Range**, and **All Off** keys.
- *Menu Navigation:* each menu has a set of configurable parameters. Menus that apply to multiple entities (for example, Input Setup could apply to Input A or B) have a first level selection to determine which entity to configure. Once the first level selection is made, the first menu parameter is displayed. The parameter label is displayed on the top line, and the current value of the parameter is displayed on the bottom line. The type of setting mode for any given parameter depends on the type of parameter highlighted. The possible setting modes are: Number Entry, Alpha-Numeric Entry, and Setting Selection. Refer to the respective entry mode descriptions below. During menu navigation, pressing **Enter** will immediately store the new parameter value. Pressing **Escape** (Exit Menu) will perform the Exit Menu function, and will *not* cancel any previous setting changes.
- *Number Entry:* allows you to enter number data using the number pad keys. Number pad keys include the numbers **0–9**, **+/-**, and decimal point. The Proportional control parameter is an example of a parameter that requires number entry. During a number entry sequence use the number entry keys to enter the number value, press **Enter** to accept the new data. Press **Escape** once to clear the entry, and press it twice to return to the Menu Navigation mode.

- *Alpha-Numeric Entry*: allows you to enter character data using the number pad keys, and the ▲ and ▼ keys. The input sensor name is an example of a parameter that requires Alpha-Numeric Entry. To edit an Alpha-Numeric parameter, press ▲ or ▼. Once in edit mode, press ▲ or ▼ to cycle through the upper and lower case English alphabet, numerals 0 through 9, and a small selection of common symbols. Press Enter to advance the cursor to the next position, or save the string and return from Alpha-Numeric Entry mode if it is in the last position. Press Escape to move the cursor back one position, or to cancel all changes and move on from the next menu parameter if the cursor is at the first position. Press any of the number pad keys, except for +/-, to enter that character into the string and advance the cursor to the next position automatically, or to save the string and return to Menu Navigation mode if the cursor is in the last position. The +/- key can be used to enter the whitespace character.
- *Setting selection*: allows you to select from a list of values. During a selection sequence, use ▲ or ▼ to cycle through the parameter values. To select the displayed parameter as the new setting, press Enter. Once Enter is pressed, the setting is saved and the next menu parameter is displayed. Pressing Escape at any time before pressing Enter will cancel any changes and exit the menu.

## 4.3 Display Setup

The intuitive front panel layout and keypad logic, the bright, vacuum fluorescent display, and the LED indicators enhance the user friendly front panel interface of the Model 335, which simultaneously displays up to four readings.

### 4.3.1 Display Modes

The Model 335 provides four display modes designed to accommodate different instrument configurations and user preferences. The display modes are listed here, and further information is provided for each display in section 4.3.1.1 to section 4.3.1.4.

- The Two Input One Loop display mode provides both sensor readings, as well as control loop information for one control loop.
- The Two Loop display mode provides the sensor reading and control setpoint for both control loops.
- The Input display mode provides detailed information about the relevant sensor input, and the associated output.
- The Custom display mode provides a means for you to assign different types of information to specific sections of the display.

Menu Navigation:

**Display Setup** → *Display Mode* → (Two Input Loop A, Two Input Loop B, Two Loop, Custom, Input A, Input A Max/Min, Input B, Input B Max/Min)

Default: Custom

Interface Command: **DISPLAY**

#### 4.3.1.1 Two Input, One Loop Modes

The Two Input One Loop display mode provides a preconfigured display that contains the most relevant information for the common configuration of one control loop and one secondary sensor. In this mode, both sensor readings are displayed on the top line, in units matching the Preferred Units setting for each.

Depending on which loop you need to monitor, you will either select Two Input Loop A, or Two Input Loop B display mode. For the loop you monitor, that sensor reading will appear in the top left display quadrant, and the other sensor reading will appear in the right display quadrant. The output number, control setpoint, heater output percentage, and heater range information for the control loop associated with the monitored input are displayed in the bottom line. FIGURE 4-3 illustrates these two displays.

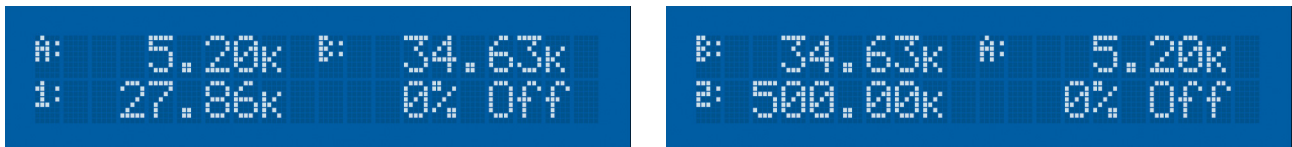

FIGURE 4-3 *Left: Two Input, Loop A, showing input A and its associated information monitored; Right: Two Input, Loop B showing input B and its associated information monitored*

Menu Navigation:

**Display Setup**→*Display Mode* (Two Input Loop A, Two Input Loop B,  
Default: Custom

Interface Command: **DISPLAY**

#### 4.3.1.2 Two Loop Mode

Two Loop mode provides a preconfigured display for the common configuration of two control loops. Each half of the display contains a sensor reading on the top, and if applicable, the setpoint of the associated control loop appears on the bottom. If the control output is in Open Loop mode, then the manual heater output setting is displayed. If the input is not assigned as the Control Input of a control loop, then the display area under the sensor reading is left blank. The sensor reading is displayed in the units assigned to the respective sensor input's Preferred Units setting, which can be found under the Input Setup menu (section 4.4).

Menu Navigation:

**Display Setup**→*Display Mode* (Two Loop Mode)

Interface Command: **DISPLAY**



FIGURE 4-4 *Two loop mode*

#### 4.3.1.3 Input Display Modes

The input display mode provides detailed information about an input sensor, and the associated control loop, if applicable, and they are most commonly accessed by pressing the A and B on the keypad. These modes are called Input A, Input A Max/Min, Input B, and Input B Max/Min in the Display Setup menu parameter list.



FIGURE 4-5 *Input display mode*

The top line of the display shows the sensor input you selected to monitor. The bottom line of the display contains all the information about the sensor input's control loop. Only the items applicable to the control loop will be displayed, specifically, the number of the control loop output, followed by the Setpoint, and Heater Output percentage and heater range. If the sensor input is not assigned as the Control Input of any control loop, then the bottom line is blank. If the control loop that uses the sensor input is in Open Loop mode, then a heater percentage is shown instead of a setpoint.



The input display modes are unique in that they can be set temporarily by pressing A or B on the front panel. After the key is pressed, the user-assignable sensor name of the respective input is displayed on the top line for 2 s, then the primary input display mode becomes active for approximately 10 s before returning to the configured display mode. Subsequent presses of the same key before the 10-second timeout period will toggle the temporary display between the primary (Input A, or Input B) and the secondary (Input A Max/Min or Input B Max/Min) temporary display modes. This provides quick access to each input and each associated control loop for gathering information or changing control loop parameters.

Press any active keys while the temporary display mode is active to reset the timeout period of the temporary display. Press **ESCAPE** to manually return the display to the configured display mode. Press and hold a temporary display key (about 3 s) until you hear an audible beep to cause the configured display mode to change to the currently displayed input display mode associated with that key.

Menu Navigation:

**Display Setup**→*Display Mode* (Input A, Input A Max/Min, Input B, Input B Max/Min)  
(each input can also be configured by pressing and holding A or B while the desired mode is displayed)

Interface Command: **DISPLAY**

#### 4.3.1.4 Custom Display Mode

The custom display mode provides the ability to customize the displayed front panel information to your preference. The display is divided into four quadrants. Each quadrant can be independently configured to display various information. These are the options available.

- None: the display location will be blank.
- Input A or Input B: after choosing Input A or Input B for a custom display location, you will be prompted to choose the units in which the sensor reading will be displayed. The choices are Kelvin, Celsius, Sensor, Min, Max, or Name. Selecting Name will display the input letter, followed by the first nine characters of the input's user configurable sensor name. If two adjacent display quadrants in the same row (locations 1 and 2, or locations 3 and 4) are both configured to display the input name, then the entire 15-character name will be displayed on the corresponding line.
- Setpoint 1 or Setpoint 2: this option displays the setpoint of the control loop associated with the specified output. If no control loop is configured (either Control Input is set to None or Output mode is set to Monitor Out or Off), then the display location will be blank. If the Output mode is set to Open Loop, then the Manual Heater Output setting will be displayed, since this is considered the setpoint for the Open Loop control mode.
- Output 1 or Output 2: this option displays the output number, followed by the heater output percentage, and the heater range of the specified output.

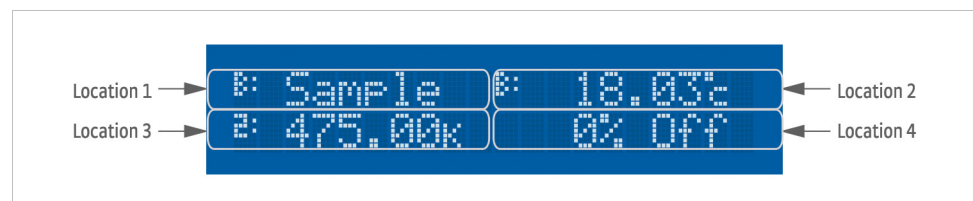

FIGURE 4-6 Custom display modes

Menu Navigation:

**Display Setup**→*Display Mode* (Custom)

Interface Command: **DISPLAY**

### 4.3.2 Display Brightness

The front panel display brightness can be adjusted for optimal viewing. The default value should work well in most standard lighting environments, but low light or bright light environments may require the brightness to be adjusted for optimal viewing.



**Use the lowest brightness setting that is acceptable; continued use of higher brightness will shorten the life of the display.**

Menu Navigation:

**Display Setup** → **ENTER** *Display Brightness* (25%, 50%, 75%, 100%)

Default: 75%

Interface Command: **BRIGT**

## 4.4 Input Setup

The Model 335 supports a variety of temperature sensors manufactured by Lake Shore and other manufacturers. An appropriate sensor type must be selected for each input. If the exact sensor model is not shown, use the sensor input performance chart in TABLE 4-6 to choose an input type with similar range and excitation. For additional details on sensors, refer to the Lake Shore Temperature Measurement and Control Catalog or visit our website at [www.lakeshore.com](http://www.lakeshore.com).



**Any unused input should be set to disabled.**

Sensor type	Display message	Input range	Excitation	Coefficient	Curve format	Lake Shore sensors*
Silicon diode	Diode	0 V to 2.5 V	10 $\mu$ A, 1 mA	Negative	V/K	DT-4XX, DT-500, DT-670 Series
Gallium aluminum arsenide diode	Diode	0 V to 10 V	10 $\mu$ A, 1 mA	Negative	V/K	TG-120 Series
Platinum RTD, rhodium-iron RTD	PTC RTD (Platinum)	0 $\Omega$ to 10 k $\Omega$ (7 ranges)	1 mA	Positive	$\Omega$ /K	PT-100 Series Platinum, RF-800 Rhodium-Iron, RF-100 Rhodium-Iron
Negative temperature coefficient (NTC) RTD	NTC RTD (Cernox™)	0 $\Omega$ to 100 k $\Omega$ (9 ranges)	100 nA to 1 mA (decade steps in power, autorange maintains <10 mV)	Negative	log $\Omega$ /K	Cernox™, Carbon Glass, Germanium, Rox™, and Thermax™
Thermocouple (option 3060 only)	Thermocouple	$\pm$ 50 mV	NA	Positive	mV/K	Chromel-AuFe (0.07%), Type E (Chromel-Constantan), Type K (Chromel-Alumel), Type T (Copper-Constantan)

\*Refer to the Lake Shore Temperature Measurement and Control Catalog for details on Lake Shore temperature sensors.

TABLE 4-6 *Sensor input types*

Menu Navigation:

**Input Setup** → *Input (A, or B)* → *Sensor Type* (Disabled, Diode, PTC RTD [Platinum], NTC RTD [Cernox], Thermocouple)

Default: Diode

Interface Command: **INTYPE**

### 4.4.1 Diode Sensor Input Setup

Diode sensors include the silicon and the gallium aluminum arsenide sensors detailed in TABLE 4-6. Input ranges are selectable to 0 V to 2.5 V or 0 V to 10 V, and standard excitation current is 10  $\mu$ A.

As an alternative to the standard diode excitation current of 10  $\mu$ A, you may select a 1 mA excitation. The 1 mA excitation current is not calibrated, and will not work properly with standard Lake Shore diode sensors. For protection against accidentally setting the 1 mA excitation current, the Diode Current setting is automatically set to 10  $\mu$ A every time the Sensor Type is set to Diode.

Menu Navigation:

**Input Setup** → *Input (A, or B)* → *Sensor Type (Diode)*

**Input Setup** → *Input (A, or B)* → *Sensor Type (Diode)* → *Range (2.5 V [Silicon] or 10 V [GaAlAs])*

**Input Setup** → *Input (A, or B)* → *Sensor Type (Diode)* → **ENTER** → *Diode Current (10  $\mu$ A or 1 mA)*

Default: *Sensor Type* → Diode

*Range* → 2.5 V (Silicon)

*Diode Current* → 10  $\mu$ A

Interface Command: **INTYPE**, **DIOCUR**

### 4.4.2 Positive Temperature Coefficient (PTC) Resistor Sensor Input Setup

PTC resistor sensors include the platinum and rhodium-iron sensors detailed in TABLE 4-6. More detailed specifications are provided in TABLE 1-2. The Model 335 supplies a 1 mA excitation current for the PTC resistor sensor type. A resistance range selection is available in order to achieve better reading resolution. Autorange is enabled by default in order to provide the best possible reading resolution, but it does not affect the sensor current excitation. Refer to section 4.4.4 for details on manually selecting the range. Current Reversal is also enabled by default in order to compensate for thermal EMF voltages. Refer to section 4.4.5 for details on the Thermal EMF Compensation (Current Reversal) feature.

Menu Navigation:

**Input Setup** → *Input (A, or B)* → *Sensor Type (PTC RTD [Platinum])*

Interface Command: **INTYPE**

### 4.4.3 Negative Temperature Coefficient (NTC) Resistor Sensor Input Setup

NTC resistor sensors include Cernox™, Rox™, Thermox™, and others detailed in TABLE 4-6. More detailed specifications are provided in TABLE 1-2. The excitation current for the NTC RTD sensor type can vary between 100 nA and 1 mA, depending on resistance range. When autoranging is enabled, the range will be automatically selected so that the excitation voltage is below 10 mV. This keeps the power dissipated in the sensor at a minimum, yet still enough to provide accurate measurements. Current Reversal is also enabled by default in order to compensate for thermal EMF voltages. Refer to section 4.4.5 for details on the Thermal EMF Compensation (Current Reversal) feature.

Menu Navigation:

**Input Setup** → *Input (A, or B)* → *Sensor Type (NTC RTD [Cernox])*

Interface Command: **INTYPE**

#### 4.4.4 Range Selection

The Model 335 is equipped with an autoranging feature that will automatically select the appropriate resistance range for the connected resistive temperature device. In some cases it may be desirable to manually select the resistance range. To manually select a resistance range, set the Autorange parameter to Off, then use the Range parameter to select the desired range. Autorange will be On by default whenever the Sensor Type parameter is set to PTC RTD or NTC RTD. Autorange is not available for the Diode sensor type.

Menu Navigation:

Input Setup→Input (A, or B)→Sensor Type (NTC RTD, NTC RTD)→Autorange (Off or On)

Input Setup→Input (A, or B)→Sensor Type (Diode)→Range (See table below)

Default: On

Interface Command: **INTYPE**

Sensor Type	Available Range Settings	Maximum Sensor Power	Sensor Excitation
Diode	2.5 V (Silicon)	25 $\mu$ W (at 10 $\mu$ A excitation)	10 $\mu$ A, 1 mA
	10 V (GaAlAs)	100 $\mu$ W (at 10 $\mu$ A excitation)	10 $\mu$ A, 1 mA
PTC RTD (Platinum)	10 $\Omega$	10 $\mu$ W	1 mA
	30 $\Omega$	30 $\mu$ W	
	100 $\Omega$	100 $\mu$ W	
	300 $\Omega$	300 $\mu$ W	
	1 k $\Omega$	1 mW	
	3 k $\Omega$	3 mW	
	10 k $\Omega$	10 mW	
NTC RTD (Cernox™)	10 $\Omega$	10 $\mu$ W	1 mA
	30 $\Omega$	2.7 $\mu$ W	300 $\mu$ A
	100 $\Omega$	1 $\mu$ W	100 $\mu$ A
	300 $\Omega$	270 nW	30 $\mu$ A
	1 k $\Omega$	100 nW	10 $\mu$ A
	3 k $\Omega$	27 nW	3 $\mu$ A
	10 k $\Omega$	10 nW	1 $\mu$ A
	30 k $\Omega$	2.7 nW	300 nA
100 k $\Omega$	1 nW	100 nA	

TABLE 4-7 Range and sensor power

#### 4.4.5 Thermal Electromotive Force (EMF) Compensation

To keep power low and avoid sensor self heating, the sensor excitation is kept low. There are two major problems that occur when measuring the resulting small DC voltages. The first is external noise entering the measurement through the sensor leads, which is discussed with sensor installation (section 2.4). The second is the presence of thermal EMF voltages, or thermocouple voltages, in the lead wiring. Thermal EMF voltages appear when there is a temperature gradient across a piece of voltage lead. Thermal EMF voltages must exist because the sensor is almost never the same temperature as the instrument. They can be minimized by careful wiring, making sure the voltage leads are symmetrical in the type of metal used and how they are joined, and by keeping unnecessary heat sources away from the leads. Even in a well-designed system, thermal EMF voltages can be an appreciable part of a low voltage sensor measurement.

The Model 335 can help with a thermal compensation algorithm. The instrument will automatically reverse the polarity of the current source every other reading. The average of the positive and negative sensor readings will cancel the thermal EMF voltage that is present in the same polarity, regardless of current direction. This correction algorithm is enabled by default for RTD sensor types, but you can turn it off using the Current Reversal parameter.

The Current Reversal parameter defaults to On any time the Sensor Type parameter is changed to PTC RTD or NTC RTD.



When Current Reversal is On, the sensor excitation current is a 10 Hz square wave (5 Hz for NTC RTD on the 100 K range). This square wave excitation generates a small electromagnetic noise signal in the sensor cable, which can be picked up by sensitive measurement equipment in the system. Turning Current Reversal off will eliminate this noise at the cost of introducing thermal EMF voltage errors into the sensor measurement.

Menu Navigation:

Input Setup → Input (A, or B) → Current Reversal (Off or On)

Default: On

Interface Command: **INTYPE**

#### 4.4.6 Thermocouple Sensor Input Setup (Model 3060 Only)

When a Model 3060 thermocouple option is installed in the Model 335, a thermocouple option becomes available under the Sensor Type parameter in the Input Setup menu. The standard diode/RTD sensor inputs can still be used when the thermocouple option is installed, but the thermocouple and standard inputs cannot be used simultaneously. Refer to section 8.12 to install the Model 3060.

Thermocouples include a variety of commercial (such as E, K, T) and specialty types such as cryogenic (Chromel-AuFe). Standard curves are included in the Model 335 for the types listed in TABLE 4-6. Other types can be used as long as an appropriate temperature response curve is loaded as a user curve. Representative thermocouple specifications are given in TABLE 1-2. The Model 335 provides one thermocouple range and no excitation because thermocouples do not require it. Internal room temperature compensation is included for convenience (section 4.4.6.2) and should be calibrated before use. Room temperature compensation is enabled by default, but can be turned off if external compensation is being used.

Menu Navigation:

Input Setup → Input (A or B) → Sensor Type (Thermocouple)

Interface Command: **INTYPE**

##### 4.4.6.1 Internal Room Temperature Compensation

Room-temperature compensation is required to give accurate temperature measurements with thermocouple sensors. It corrects for the temperature difference between the instrument thermal block and the curve normalization temperature of 0 °C. An external ice bath is the most accurate form of compensation, but is often inconvenient. The Model 335 has internal room-temperature compensation that is adequate for most applications. The internal compensation can be turned on or off by the user. It operates with any thermocouple type that has an appropriate temperature response curve loaded. Room-temperature compensation is not meaningful for sensor units measurements.



**Room temperature compensation should be calibrated as part of every installation (section 4.4.6.2).**

Menu Navigation:

Input Setup → Input (A or B) →  → Room Compensation (Off or On)

Default: On

Interface Command: **INTYPE**

##### 4.4.6.2 Internal Room Temperature Compensation Calibration Procedure

Factory calibration of the instrument is accurate to within approximately  $\pm 1$  K. Differences in thermocouple wire and installation technique create errors greater than the instrument errors. The best accuracy is achieved by calibrating with the thermocouple actually being used, because it eliminates most sources of error. If that is not possible, use a thermocouple made from the same wire.



**It is best practice to use the same material for thermocouple wires; if it is at all possible, it is also best to avoid splices. When splices are necessary, continue the splice with the same type of material.**

For less demanding applications, a short across the input terminals will suffice. Both thermocouple inputs should be calibrated on either channel A or B, even if they use the same type of thermocouple. An appropriate curve must be selected and room temperature compensation must be turned on before calibration can be started.

Follow this procedure to calibrate room temperature compensation:



**For best results, the calibration temperature should be close to the measurement temperature that requires best accuracy.**

1. Attach a thermocouple sensor or direct short across the input terminals of the thermocouple input. See FIGURE 3-7 for polarity.
2. Place the instrument away from drafts. If you are calibrating using a short, place an accurate room-temperature thermometer near the terminal block.
3. Allow the instrument to warm up for at least 0.5 h without moving or handling the sensor.
4. If you are calibrating with a short, skip to step 6, otherwise insert the thermocouple into the ice-bath, liquid nitrogen, helium Dewar, or other known, fixed temperature.
5. Read the displayed temperature. If the temperature display is not as expected, check to be sure that the thermocouple is making good thermal contact. If possible, add a thermal mass to the end of the thermocouple.
6. Press **Input Setup** and select the corresponding sensor input. Press **Enter** until the Room Calibration parameter appears, then press **▲** until Yes appears; press **Enter** to accept it.
7. The current temperature reading is displayed in kelvin. Enter the true temperature that the thermocouple should read. If the input is shorted, then enter the actual room temperature measured by the thermometer. Press **Enter** to save the value.
8. To verify the calibration, check that the temperature reading for the calibrated input matches the room temperature calibration setting value.

Any previous calibration can be cleared using the Clear Calibration submenu.

Menu Navigation:

**Input Setup**→*Room Calibration*→*Clear Calibration*

Default: Room calibration cleared

## 4.4.7 Curve Selection

The Model 335 supports a variety of temperature sensors manufactured by Lake Shore and other manufacturers. After the appropriate sensor type is selected (section 2.2), an appropriate curve may be selected. The Model 335 can use curves from several sources. Standard curves are preloaded with every instrument, and they are numbered 1 to 20. User curves, numbered 21 to 59, can be used when a sensor does not match a standard curve. SoftCal™ calibrations are stored as user curves or the user can enter their own curves from the front panel (section 5.9) or computer interface (section 6.2). The complete list of sensor curves preloaded in the Model 335 is provided in TABLE 4-8.

During normal operation, only the curves that share the input type you have selected are displayed. If the curve you wish to select does not appear in the selection sequence, make sure the curve format matches the recommended format for the input type selected. Refer to TABLE 4-6.



The sensor reading of the instrument can always be displayed in sensor units. If a temperature response curve is selected for an input, its readings may also be displayed in temperature.

Curve number	Curve name	Sensor type	Model number	Temperature range**	For data points, refer to:
01	DT-470	Diode	DT-470	1.4 K to 475 K	Table D-1
02	DT-670	Diode	DT-670	1.4 K to 500 K	Table D-2
03	DT-500-D*	Diode	DT-500-D	1.4 K to 365 K	Table D-3
04	DT-500-E1*	Diode	DT-500-E1	1.1 K to 330 K	Table D-3
05	Reserved	—	—	—	—
06	PT-100	PTC RTD	PT-100	30 K to 800 K	Table D-4
07	PT-1000*	PTC RTD	PT-1000	30 K to 800 K	Table D-4
08	RX-102A-AA	NTC RTD	Rox RX-102A	0.05 K to 40 K	Table D-5
09	RX-202A-AA	NTC RTD	Rox RX-202A	0.05 K to 40 K	Table D-6
10	Reserved	—	—	—	—
11	Reserved	—	—	—	—
12	Type K	Thermocouple	Type K	3 K to 1645 K	Table D-7
13	Type E	Thermocouple	Type E	3 K to 1274 K	Table D-8
14	Type T	Thermocouple	Type T	3 K to 670 K	Table D-9
15	AuFe 0.03%*	Thermocouple	AuFe 0.03%*	3.5 K to 500 K	Table D-10
16	AuFe 0.07%	Thermocouple	AuFe 0.07%	3.15 K to 610 K	Table D-11
17	Reserved	—	—	—	—
18	Reserved	—	—	—	—
19	Reserved	—	—	—	—
20	Reserved	—	—	—	—
21 to 59	User curves	—	—	—	—

\* No longer offered by Lake Shore

\*\*Instrument may not support the sensor over its entire range

TABLE 4-8 Sensor curves

Once the input is configured (section 4.4), you may choose a temperature curve. Any standard or user curve that matches the format of the sensor type configured for a given input will be available under the Curve parameter in the Input Setup menu for that input. You are also given the choice of None. When set to None, the front panel readings configured for kelvin or Celsius will display the NOCURV message and the interface will report 0 K and  $-273.15\text{ }^{\circ}\text{C}$  for KRDG and CRDG queries, respectively. Data points for standard curves are detailed in Appendix C.

Menu Navigation:

Input Setup → Input (A, or B) → → Curve (Any curve of matching type)

Interface: INCRV

#### 4.4.8 Filter

The reading filter applies exponential smoothing to the sensor input readings. If the filter is turned on for a sensor input, all reading values for that input are filtered. The filter is a running average so it does not change the update rate of an input. Filtered readings are not used for control functions, but they are used for all input features including Max/Min.

The number of filter points determines filter bandwidth. One filter point corresponds to one new reading on that input. A larger number of points does more smoothing, but also slows the instrument's response to real changes in temperature. The default number of filter points is eight, which settles to within six time constants of a step change value in 45 readings, or 4.5 s.

The time constant (time it takes to settle to within 36.8% of the step value after a step change) for a given number of filter points can be derived using the following formula:



$TC = 0.1 / (\ln(N / (N - 1)))$ , where TC is one time constant, and N is the number of filter points. A reading is usually considered settled after six time constants. TABLE 4-9 shows a sampling of filter settings and the resulting time constant, settle time, and equivalent noise bandwidth.

Filter points	Time constant	Settle time (6 time constants)	Equivalent noise bandwidth (1/4 TC)
2	0.14 s	0.9 s	1.733 Hz
4	0.35 s	2.1 s	0.719 Hz
8	0.75 s	4.5 s	0.334 Hz
16	1.55 s	9.3 s	0.161 Hz
32	3.15 s	18.9 s	0.079 Hz
64	6.35 s	38.1 s	0.039 Hz

TABLE 4-9 Filter settle time and bandwidth

The filter window is a limit for restarting the filter. If a single reading is different from the filter value by more than the limit, the instrument will assume the change was intentional and restart the filter. Filter window is set in percent of full scale range.

Menu Navigation:

Input Setup → Input (A, or B) →  → Filter (Off or On)

Input Setup → Input (A, or B) →  → Filter Points (2 to 64)

Input Setup → Input (A, or B) →  → Filter Window (1% to 10%)

Default:

Filter → (Off)

Filter Points → 8

Filter Window → 10%

Interface: **FILTER**

#### 4.4.9 Input Name

To increase usability and reduce confusion, the Model 335 provides a means of assigning a name to each sensor input. The designated input name is displayed on the front panel when the A or B keys are pressed, identifying the respective sensor. The input name can also be configured to be displayed when using the custom display mode. Refer to section 4.2.3 for Alpha-Numeric entry.



**Depending on the display mode you have chosen, the input name may show only nine characters.**

Menu Navigation:

Input Setup → Input (A, or B) →  → Input Name (15 character string)

Default: Input (A, or B)

Interface Command: **INNAME**

#### 4.4.10 Temperature Limit

The Temperature Limit parameter provides a means of protecting your equipment from damage by shutting down all control outputs when the assigned temperature limit is exceeded on the sensor input. The parameter is available for both sensor inputs. A temperature limit of 0 K (default value) turns this feature off.

Menu Navigation:

Input Setup → Input (A, or B) →  → Temperature Limit (0 K to 2999 K)

Default: 0.0000 K

Interface Command: **TLIMIT**



#### 4.4.11 Preferred Units

The Preferred Units parameter setting determines which units are used to display setpoint and max/min parameters whenever these parameters are displayed in any display mode. The sensor reading is also displayed in Preferred Units in all display modes except for the Custom display mode, where each sensor location can be assigned specific display units.

Menu Navigation:

**Input Setup** → *Input (A, or B)* → **ENTER** → *Preferred Units (Kelvin, Celsius, or Sensor)*

Interface: **INTYPE**

#### 4.4.12 Max/Min

The Max/Min feature captures and stores the highest (Max) and lowest (Min) reading taken since the last reset. The Preferred Units parameter, under the Input Setup menu, determines the units used for capturing Max and Min.

Max and Min are always being captured, so there is no need to turn the feature on or off. The readings are reset when the instrument is turned on, sensor input parameters are changed, or the **Max/Min Reset** key is pressed.

Menu Navigation:

**Max/Min Reset**

Interface: **MNMXRST**

### 4.5 Output and Control Setup

Once the sensor inputs have been configured (section 4.4), the outputs can be configured. The Output Setup menu is used to create control loops for controlling temperature, whether using feedback (closed loop) or manually setting the output (open loop). This section describes how to operate the output and control features, and how to set control parameters. Each control parameter should be considered before turning on a control loop output or the instrument may not be able to perform the most simple control functions. A good starting point is deciding which control loop to use, whether to operate in open or closed control mode and which tuning mode is best for the application. Other parameters fall into place once these have been chosen. Section 2.7 of this manual describes the principals of closed loop proportional, integral, and derivative (PID) control.

#### 4.5.1 Heater Outputs

Heater Outputs 1 and 2 are traditional control loop heater outputs for a cryogenic temperature controller. The two outputs are identical except in the amount of power available. Output 1 can provide up to 75 W when Output 2 is configured as a voltage output, or 50 W when Output 2 is configured as a current output. Output 2 can provide up to 25 W when configured as a current output, and 1 W when it is configured as a voltage output.

The outputs include a large set of hardware and software features, making them very flexible and easy to use. The current outputs are well-regulated DC outputs. This provides quiet, stable control for a broad range of temperature control systems in a fully integrated package. The power ranges for each output provide decade steps in power.

Menu Navigation:

**Output Setup** → *Output (1 or 2)*

Default: Current

Interface: **HTRSET**

#### 4.5.1.1 Heater Output Type (Output 2)

Heater Output 2 can be configured either as a standard current source output, which can provide up to 25 W of power into a 25  $\Omega$  or 50  $\Omega$  heater, or as a voltage output, which can provide up to 1 W of power into a 100  $\Omega$  heater. The Output Type parameter, only available for Output 2, determines which type of output and which rear panel connector is used.

Menu Navigation:

**Output Setup**→*Output 2*→*Output Type* (Current or Voltage)

Default: Current

Interface: **HTRSET**

#### 4.5.1.2 75 W Configuration

The Model 335 can provide a total of 75 W of power. In the standard configuration, Output 1 can provide up to 50 W and Output 2 can provide up to 25 W into either a 25  $\Omega$  or 50  $\Omega$  heater. Alternatively, when Output 2 is configured as a voltage output, its power can be diverted to Output 1, which can then provide up to 75 W into a 25  $\Omega$  heater. In this configuration, Output 2 can still provide 1 W into a 100  $\Omega$  heater.

Follow this procedure to configure Output 1 for up to 75 W.

1. Set the Heater Output Type setting for Output 2 to Voltage.
2. Ensure that the Heater Resistance setting for Output 1 is set to 25  $\Omega$ . The 1.732 A (75 W) setting will then be available for the Max Current setting on Output 1.
3. Apply this setting (1.732 A (75 W) setting) to get the desired 75 W output.
4. Alternatively, the User setting can be used for the Max Heater Output setting to set the maximum current to any value from 0.1 A to 1.732 A.

Once a Max Current setting of more than 1.41 A is applied, the Heater Output Type for Output 2 cannot be set back to Current until the Max Current setting for Output 1 is reduced to 1.41 A or less. Refer to section 4.5.1.1 for information about the Heater Output Type setting. Refer to section 4.5.1.3 for information about the Max Current and Heater Resistance settings.

Configuration	Output	Source output	Power	Heater
50 W + 25 W	Output 1	Current	Up to 50 W	25 $\Omega$ or 50 $\Omega$
	Output 2		Up to 25 W	
75 W + 1 W	Output 1	Current	Up to 75 W	25 $\Omega$
	Output 2	Voltage	1 W	100 $\Omega$

TABLE 4-10 Heater output configurations

Menu Navigation:

**Output Setup**→*Output 2*→*Voltage*→**ENTER**→**Output Setup**→*Output 1*→**ENTER**→Max Current (0.1 A to 1.732 A)

Default: Current

Interface: **HTRSET**

#### 4.5.1.3 Max Current and Heater Resistance

The Model 335 heater outputs are designed to work optimally into a 25  $\Omega$  or 50  $\Omega$  heater. The Heater Resistance and Max Current parameters work together to limit the maximum available power into the heater. This is useful for preventing heater damage or limiting the maximum heater power into the system. When using a 25  $\Omega$  or 50  $\Omega$  heater, set the Heater Resistance parameter accordingly. The Max Current set-

ting will then provide multiple discrete current limit values that correspond to common heater power ratings. The available current limits keep the output operating within the voltage compliance limit to ensure the best possible resolution. These parameters work with the Heater Range parameter (section 4.5.1.7.8) to provide safety and flexibility.

If you are not using a standard heater resistance, set the Heater Resistance setting to 25  $\Omega$  for any resistance less than 50  $\Omega$ , or to 50  $\Omega$  for any higher heater resistance. The user max current setting is useful when using a non-standard heater resistance value. Refer to section 4.5.1.3.1 for more information on User Max Current. TABLE 4-11 provides examples of different heater resistances and max current settings, and the resulting maximum heater power. The maximum heater powers in bold represent the discrete current limits available under the Max Current setting for 25  $\Omega$  and 50  $\Omega$  heaters.



**The 1.732 A (75 W) Max Current setting is only available on Output 1 when Output 2 is configured for Voltage Mode. When Max Current is configured to 1.732 A on Output 1, the Current Mode setting will not be available on Output 2. In order to set Output 2 to Current Mode, the Max Current setting on Output 1 must be configured to 1.41 A or less.**

Menu Navigation:

Output Setup  $\rightarrow$  Output (1, or 2)  $\rightarrow$   $\overline{\text{ENTER}}$   $\rightarrow$  Heater Resistance (25  $\Omega$  or 50  $\Omega$ )

Output Setup  $\rightarrow$  Output (1, or 2)  $\rightarrow$   $\overline{\text{ENTER}}$   $\rightarrow$  Max Current (User, 0.707 A, 1 A, or 1.732 A)

Default:

Heater Resistance  $\rightarrow$  25  $\Omega$

Output 1  $\rightarrow$  Max Current (1.414 A)

Output 2  $\rightarrow$  Max Current (1 A)

Interface Command: HTRSET

#### 4.5.1.3.1 User Max Current

The provided discrete Max Current settings of 0.707 A, 1 A, 1.414 A, and 1.732 A are available for the common heater resistor values of 25  $\Omega$  and 50  $\Omega$ , and for various common heater power ratings. If you are using a heater that deviates from these common values, the User Max Current setting is provided.

The optimal maximum current value should be calculated based on the heater's power rating or the maximum desired heater output power, whichever is lower. The heater output compliance voltage should also be taken into account in order to maximize heater setting resolution. This calculated current limit can then be entered using the User Max Current setting.

To calculate the Max Current setting based on a heater or load power limit, calculate current, I, using both of the following equations:  $I = \text{Sqrt}(P/R)$  and  $I = V/R$  where P is the maximum allowable power, V is the output compliance voltage (50 V for Output 1 and 35.5 V for Output 2), and R is the heater resistance. The load power limit and voltage compliance limit of the heater output are in place at the same time, so the lower calculated current is the correct User Max Current setting.

Example 1: A 50  $\Omega$ , 30 W heater is connected to Output 1.

Power I Limit	Voltage compliance limit
$I = \text{Sqrt}(P/R)$	$I = V/R$
$I = \text{Sqrt}(30 \text{ W}/50 \Omega)$	$I = 50 \text{ V}/50 \Omega$
$I = 0.77 \text{ A}$	$I = 1 \text{ A}$

User Max Current should be set to the smaller of the two or 0.77 A. In this example, the desired 30 W of power is available to the heater.

Example 2: A 75 Ω, 50 W heater is connected to Output 2.

Power limit	Voltage compliance limit
$I = \text{Sqrt}(P/R)$	$I = V/R$
$I = \text{Sqrt}(50 \text{ W}/75\Omega)$	$I = 35.5 \text{ V}/75\Omega$
$I = 0.81 \text{ A}$	$I = 0.47 \text{ A}$

User Max Current should be set to the smaller of the two, or 0.47 A. In this example, only 16.5 W of the total 25 W of power is available to the heater.

To enter a User Max Current, set the Heater Resistance setting to 25 Ω for any resistance less than 50 Ω, or to 50 Ω for any higher heater resistance. Set the Max Current setting to User. The User Max Current setting becomes available in the Output Setup menu. Enter the calculated current limit value in the User Max Current parameter.

Max Current	Heater resistance					
	10 Ω	25 Ω	30 Ω	40 Ω	50 Ω	100 Ω
1.732 A	30 W	<b>75 W</b>	x	x	x	x
1.667 A (User)	28 W	69.5 W		x	x	x
1.414 A	20 W	<b>50 W</b>	60 W	x	x	x
1.25 A (User)	15 W	39 W	46 W	62.5 W	x	x
1 A	10 W	<b>25 W</b>	30 W	40 W	<b>50 W</b>	x
0.707 A	5 W	<b>12.5 W</b>	15 W	20 W	<b>25 W</b>	x
0.5 A (User)	2.5 W	6 W	7.5 W	10 W	12.5 W	25 W

Shaded dark blue: Max current too high for these resistances due to voltage compliance limit

Shaded light blue: Maximum current/power only available on heater output 1

Bold: Discrete options available for 25 Ω and 50 Ω heaters under the Max Current setting

TABLE 4-11 User Max Current

Menu Navigation:

Output Setup → Output (1, or 2) →  → Heater Resistance (25 Ω or 50 Ω) → Max Current → User (0.1 A to 1.732 A)

Default:

Output 1 → User Max Current (1.414 A)

Output 2 → User Max Current (1 A)

Interface: **HTRSET**

#### 4.5.1.4 Power Up Enable

All configuration parameters of the Model 335 can be retained through a power cycle. Some systems require that the heater range is turned off when power is restored. The power up enable feature allows the user to choose whether or not the heater range is turned off each time the instrument power is cycled. Setting the Power Up Enable parameter to Off ensures that the heater range is turned off on power up. Setting it to On will return the Heater Range to its previous setting when power is restored.

Menu Navigation:

Output Setup → Output (1 or 2) →  → Power Up Enable (Off or On)

Default: Off

Interface Command: **OUTMODE**

#### 4.5.1.5 Heater Out Display

The heater output can be displayed in units of percent of full scale current or percent of full scale power. The heater output display on the front panel is displayed in these units, and the Manual Output parameter is set in these units. The availability of full scale current and power is determined by the heater resistance, max current setting, and heater range.



**The heater output display is a calculated value intended to aid in system setup and tuning. It is not a measured value, and may not accurately represent actual power in the heater.**

Menu Navigation:

**Output Setup** → *Output (1 or 2)* →  → *Heater Out Display (Current or Power)*

Default: Current

Interface Command: **HTRSET**

#### 4.5.1.6 Output Modes

You can configure the heater outputs in one of four output modes: Off, Closed Loop PID, Zone, or Open Loop. The Off mode prevents current from being sourced to the given output. Closed Loop PID is the mode most often used for controlling temperature. Zone mode builds on the Closed Loop mode by providing automatic changing of control parameters on up to ten different temperature zones. Open Loop mode provides a means of applying a constant current to the output.

Menu Navigation:

**Output Setup** → *Output (1 or 2)* → *Output Mode (Off, Closed Loop PID, Zone, Open Loop)*

Default: Off

Interface Command: **OUTMODE**

##### 4.5.1.6.1 Closed Loop PID Mode

The Closed Loop PID mode is the most commonly used closed loop control mode for tightly controlling temperature using the heater outputs of the Model 335. In this mode the controller attempts to keep the load exactly at the setpoint temperature you entered. To do this, it uses feedback from the control input sensor to calculate and actively adjust the control output setting. The Model 335 uses a control algorithm called PID that refers to the three terms used to tune the control. Refer to section 4.4.9 for details on assigning a Control Input for the closed loop feedback. Refer to section 2.7 and section 2.8 for a detailed discussion of PID control and manual tuning.

In Closed Loop PID mode, the controller will accept user-entered Proportional, Integral, and Derivative parameters to provide 3-term PID control. Manual output can be used during closed loop control to add to the calculated PID control output.

Menu Navigation:

**Output Setup** → *Output (1 or 2)* → *Output Mode (Closed Loop PID)*

Interface: **OUTMODE**

##### 4.5.1.6.2 Zone Mode

Optimal control parameter values are often different at different temperatures within a system. Once control parameter values have been chosen for each temperature range (or zone), the instrument will update the control settings each time the setpoint crosses into a new zone. If the settings are changed manually, the controller will use the new setting while it is in the same zone and will update to the programmed zone table settings when the setpoint crosses into a new zone.



**If desired, the control parameters can be changed manually, just like Closed Loop PID mode, but they will be automatically updated once the setpoint crosses a zone boundary.**

The control algorithm used for each zone is identical to that used in Closed Loop PID mode. The Zone feature is useful by itself, but it is even more powerful when used with other features. We recommend using zone mode with setpoint ramping (section 4.5.1.7.7). Refer to section 5.3 for details on setting up zones. Refer to section 2.7 for a detailed discussion of PID control.

Menu Navigation:

Output Setup→Output (1 or 2)→Output Mode (Zone)

Interface: OUTMODE

#### 4.5.1.6.3 Open Loop Mode

Open Loop output mode allows you to directly set the output using only the Manual Output and Range parameters. This guarantees constant current to the load, but it does not actively control temperature. Any change in the characteristics of the load will cause a change in temperature.

Any output can be configured to Open Loop mode. When an output is configured in this mode, the Manual Output and Heater Range parameters become available in the Output Setup menu for setting the output. For convenience, the Control Input parameter can be used to assign a sensor input, which then allows the output to be displayed on the front panel when using that sensor input's display mode. When displayed on the front panel, the Manual Output and Heater Range direct operation keys can be used for one touch access to these settings. Refer to section 4.3.1 for details on configuring display modes.



**Since there is no sensor feedback in open loop mode, there is nothing to prevent the system from being overheated. We recommend using the Temperature Limit feature to help protect the system from overheating. Refer to section 4.4.10 for temperature limits.**

Menu Navigation:

Output Setup→Output (1 or 2)→Output Mode (Open Loop)

Interface: OUTMODE

#### 4.5.1.7 Control Parameters

Once the output mode is chosen, the control parameters can be used to begin controlling temperature. Control Input is used to create a control loop. The P, I, and D parameters provide fine tuning of the control algorithm. Manual Output provides a baseline output power about which to control. Setpoint is used to set the desired target temperature, and Heater Range is used to turn on the control output, as well as to set the power range of the output. These parameters are described in detail in section 4.5.1.7.1 to section 4.5.1.7.8.

##### 4.5.1.7.1 Control Input

For closed loop control (Closed Loop PID, Zone, Warm Up Supply), a control loop must be created. A control loop consists of a control output for controlling the temperature, and an input for feedback into the control algorithm. Use the Control Input parameter to assign the control input sensor to the desired output.

In the Monitor Out mode, the Control Input parameter is used to determine the source of the output voltage. In the Open Loop mode, the Control Input parameter can be set simply for convenience in order to easily access the associated output's Manual Output and Heater Range parameters using the Direct Operation keys. Refer to section 4.2.1.1 for details on Direct Operation keys.

Menu Navigation:

**Output Setup**→*Output* (1 or 2)→**ENTER**→*Control Input* (None, Input A, Input B)

Default:

*Output 1*→*Control Input*→(Input A)

*Output 2*→*Control Input*→(Input B)

Interface Command: **OUTMODE**

#### 4.5.1.7.2 Proportional (P)

The proportional parameter (also called gain) is the P part of the PID control equation. It has a range of 0 to 1000 with a resolution of 0.1. The default value is 50. Enter a value greater than 0 for P when using closed loop control.

To set P, first configure the front panel display to show the desired control loop information, then use the P key on the front panel. A quick way to access the setting if the control loop information is not already being displayed, is to use the front panel A or B keys to temporarily display the control loop information while the new setting is entered. Refer to section 4.3 for details on configuring the front panel display.

Menu Navigation:

**P**→(0 to 1000)

Default: 50

Interface Command: **PID**

#### 4.5.1.7.3 Integral (I)

The integral parameter (also called reset) is the I part of the PID control equation. It has a range of 0 to 1000 with a resolution of 0.1. The default value is 20. Setting I to 0 turns the reset function off. The I setting is related to seconds by:

$$I_{\text{setting}} = 1000 / I_{\text{seconds}}$$

For example, a reset number setting of 20 corresponds to a time constant of 50 s. A system will normally take several time constants to settle into the setpoint. The 50 s time constant, if correct for the system being controlled, would result in a system that stabilizes at a new setpoint in between 5 min and 10 min.

To set I, first configure the front panel display to show the desired control loop information, then use the I key on the front panel. A quick way to access the setting if the control loop information is not already being displayed is to use the front panel A or B keys to temporarily display the control loop information while the new setting is entered. Refer to section 4.3 for details on configuring the front panel display.

Menu Navigation:

**I**→(0 to 1000)

Default: 20

Interface Command: **PID**

#### 4.5.1.7.4 Derivative (D)

The derivative parameter (sometimes called rate) is the D part of the PID control equation. The derivative time constant should normally be somewhere between  $\frac{1}{4}$  and  $\frac{1}{8}$  the integral time in seconds, if used at all. As a convenience to the operator, the Model 335 derivative time constant is expressed in percent of  $\frac{1}{4}$  the integral time. The range is between 0% and 200%. Start with settings of 0%, 50%, or 100%, and determine which setting gives you the type of control you desire. Do not be surprised if the setting you prefer is 0%. Note that by using a percent of integral time, derivative scales automatically with changes in the integral value and does not have to be revisited frequently.

To set D first configure the front panel display to show the desired control loop information, then use the **D** key on the front panel. A quick way to access the setting if the control loop information is not already being displayed is to use the front panel **A** or **B** keys to temporarily display the control loop information while the new setting is entered. Refer to section 4.3 for details on configuring the front panel display.

Menu Navigation:

**D**→(0% to 200%)

Default: 0%

Interface Command: **PID**

#### 4.5.1.7.5 Manual Output

Manual Output is a manual setting of the control output. It can function in two different ways, depending on control mode. In open loop control mode, the Manual Output is the only output to the load. The user can directly set control output from the front panel or over the computer interface. In closed loop control mode, Manual Output is added directly to the output of the PID control equation. In effect, the control equation operates about the Manual Output setting.

The Manual Output setting is expressed in percent of full scale. Percent of full scale is defined as percent of full scale current or power on the selected heater range. Refer to section 4.5.1.5 to set the Heater Out display. Available full scale current and power are determined by the heater resistance, Max Current setting, and Heater Range. Manual Output setting range is 0% to 100% with a resolution of 0.01%.

To set Manual Output first configure the front panel display to show the desired control loop information, and then use the **Manual Out** key on the front panel. A quick way to access the setting if the control loop information is not already being displayed is to use the front panel **A** or **B** keys to temporarily display the control loop information while the new setting is entered. Refer to section 4.3 for details on configuring the front panel display.

When an output is configured for Open Loop mode, the Manual Output setting is available in the Output Setup menu. This is because in the Open Loop mode no Control Input (feedback sensor) is required, and if none is set then there would be no way to use the **Manual Out** front panel key to set the output, unless you are in the Custom Display mode. The Control Input parameter can be assigned to a sensor input (that is not being used for closed loop control) as a means of quickly accessing the Manual Output setting using the **Manual Out** front panel key.

Menu Navigation:

**Manual Out**→(0% to 100%)

Default: 0%

Interface Command: **MOU**



#### 4.5.1.7.6 Setpoint

The Setpoint parameter is used to set the desired load temperature for a control loop. Before a setpoint can be entered, a control loop must be created by configuring an input sensor and assigning it to a control output using the Control Input parameter. The Setpoint can be entered in either temperature units or sensor units, based on the sensor input's Preferred Units setting. The Setpoint Ramping feature is available when controlling in temperature units to provide smooth, continuous control from one temperature to the next. Refer to section 4.4 for details on Input Setup. Refer to section 4.5.1.7.1 for details on assigning a Control Input. Refer to section 4.5.1.7.7 for details on the Setpoint Ramping feature.

Most applications require control in units of temperature. To control in units of temperature, set the Preferred Units parameter of the control input sensor to either kelvin or Celsius. When controlling in temperature, the available setting range of the setpoint is limited by the Setpoint Limit parameter of the assigned temperature curve. Refer to section 4.4.11 for details on setting the Preferred Units parameter. Refer to section 5.8.2 for details on setting a curve Setpoint Limit.



**The Setpoint Limit feature only limits the Setpoint entry. For even greater protection, the Temperature Limit feature can be used to turn off all heater outputs if a sensor reading above the specified temperature is observed. Refer to section 4.4.10 for details on the Temperature Limit feature.**

There are some instances when temperature control in sensor units may be desired, for example when a temperature curve is not available. For these applications, the Model 335 can control temperature in sensor units. To control in sensor units, set the Preferred Units parameter to sensor. When controlling in sensor units, the Setpoint resolution matches the display resolution for the sensor input type given in the specifications (section 1.3).



**Temperature control in sensor units can be unpredictable since most sensors do not have a linear response to temperature, and therefore have can have different sensitivity in different temperature ranges.**

When changing the Preferred Units from sensor to temperature (kelvin or Celsius), or from temperature to sensor, the Model 335 converts the setpoint to the new control units by using the assigned temperature curve. This provides minimal disruption in the control output when changing the Preferred Units parameter while the control loop is active.

Menu Navigation:  
Setpoint→(See note below)



**When controlling in temperature, the setpoint is limited by the control input temperature curve's Setpoint Limit. When controlling in sensor units, the setpoint is limited by the limits of the configured control sensor.**

Default: 0.0000 K  
Interface Command: **SETP**

#### 4.5.1.7.7 Setpoint Ramping

The Model 335 can generate a smooth setpoint ramp when the setpoint units are expressed in temperature. You can set a ramp rate in degrees per minute with a range of 0 to 100 and a resolution of 0.1. Once the ramping feature is turned on, its action is initiated by a setpoint change. When a new setpoint is entered, the instrument changes the setpoint temperature from the old value to the new value at the ramp rate. A positive ramp rate is always entered; it is used by the instrument to ramp either up or down in temperature.

Always use the ramping feature to minimize temperature overshoot and undershoot. When ramping is not used, a setpoint change can cause the error used by the PID equation to become very large, which causes the I contribution of the control output equation to become larger the longer the error exists. This will result in a large overshoot or undershoot once the setpoint temperature is reached, since the I contribution will only decrease when the error polarity is reversed. Using a ramp rate that keeps the control output from reaching the extremes of 100% or 0% while ramping is optimal.

The ramping feature is useful by itself, but it is even more powerful when used with other features. Setpoint ramps are often used with zone control mode. As temperature is ramped through different temperature zones, control parameters are automatically selected for best control. Ramps can be initiated and status read back using a computer interface. During computer-controlled experiments, the instrument generates the setpoint ramp while the computer is busy taking necessary data.



**When an incomplete ramp is shut off, the setpoint will remain on the most current setting (the reading will not jump to the end of the ramp).**



**If the input type or input curve is changed while a ramp is in progress, both ramping and the heater are turned off.**



**If Ramp is on and the setpoint is set to sensor units, the ramping function will remain on, but when another setpoint is entered, the setpoint goes directly to the new setpoint value.**



**To bypass ramping and load the setpoint with the current temperature, with the control loop displayed, press and hold the Setpoint button for 3 s.**

Menu Navigation:

**Output Setup** → **Output (1 or 2)** → **ENTER** → **Setpoint Ramping (Off or On)**

Default: Off

**Ramp Rate** → (0.1 K/min to 100 K/min)

Default: 0.1 K/min

Interface Command: **RAMP**

To stop a ramp, when the desired control loop is displayed, press **Setpoint** then immediately press **Enter**. This stops the ramp at the current setpoint, but it leaves the ramping function activated. To continue the ramp, enter a new setpoint. Refer to section 4.5.1.7.6 for details on setting the Setpoint parameter.

#### 4.5.1.7.8 Heater Range

The Heater Range setting is used for turning a control output on, as well as setting the output power range for the heater outputs. Both outputs provide an Off setting for turning the output off. The heater outputs in Current mode provide Low, Medium (Med), and High settings, which provide decade steps in power, based on the maximum output power available to the connected heater. The High range provides the maximum power, the Med range provides (maximum power)/10 and the Low range provides (maximum power)/100. Refer to section 2.5.1 for details on how to calculate the maximum output power. When Output 2 is configured as a voltage output, only one output range (On) is available.



**While controlling temperature, the following will cause the heater range to automatically turn off:**

- Exceeding the Temperature Limit setting
- Setup changes to the control input
- Power loss with Power Up Enable feature turned off
- Input errors such as T. Over, T. Under, S. Over, and S. Under



**Available full scale current and power are determined by the heater resistance, Max Current setting, and Heater Range.**

Specifications of the heater outputs are provided in section 1.3. Heater theory of operation is provided in section 2.5. Various heater installation considerations are provided in section 3.7.

To set Heater Range, first configure the front panel display to show the desired control loop information, then use the **Heater Range** key on the front panel. A quick way to access the setting if the control loop information is not already displayed is to use the front panel A or B keys to temporarily display the control loop information while the new setting is entered. Refer to section 4.2 for details on configuring the front panel display.

Menu Navigation:

**Heater Range**→(Off, On, Low, Med, High)

Default: Off

Interface Command: **RANGE**

#### 4.5.1.7.9 ALL OFF

The **ALL OFF** key is provided as a means of shutting down all control outputs with one key. It is equivalent to setting the Heater Range parameter of both outputs to Off.



**This function is always active even if the keypad is locked or when it is in remote mode.**

## 4.5.2 Voltage Output

The voltage output available for Output 2 is a variable DC voltage source that has a range from -10 V to +10 V. The voltage is generated by a 16-bit D/A converter with resolution of 0.3 mV or 0.003% of full scale. This output can be configured to Closed Loop PID, Zone, Open Loop, Warm Up Supply, or Monitor Out modes. The Closed Loop PID mode can be used to control temperature. It can also be set up for bipolar PID control, which is useful when controlling a thermoelectric device. Refer to section 2.11 for more information on setting up thermoelectric devices. The Open Loop mode can be used to set the output to a specific, constant value. Refer to section 4.5.1.6.3 for details on Open Loop Mode. The Warm Up Supply mode uses the output to drive the programming input for an external power supply for the purpose of rapidly warming a system to a user-specified temperature. The Monitor Out mode uses the output to provide a voltage proportional to an input sensor reading to be used by an external device such as a data logger.



The voltage output is designed to provide up to 1 W into a 100  $\Omega$  heater. The output is current limited to slightly over 100 mA, and therefore, a heater value less than 100  $\Omega$  can drive the output into current limit. This condition will not damage the output, but it can result in discontinuous temperature control.

#### 4.5.2.1 Warm Up Supply

Warm Up Supply mode is designed for controlling an external power supply used for rapidly increasing the temperature in the controlled system, for example, to bring a system to room temperature in order to change samples. Refer to section 5.5 for more information on warm up supply operation. Refer to section 3.7.5 for the procedure to install an external power supply for warm up supply mode.

Menu Navigation:

**Output Setup**→Output 2→Voltage→WarmUp Supply

Interface Command: **OUTMODE**

#### 4.5.2.2 Monitor Out

Refer to section 5.6 for more information on Monitor Out mode.

Menu Navigation:

**Output Setup**→Output 2→Voltage→Monitor Out

Interface Command: **OUTMODE**

## 4.6 Interface

The Model 335 has two computer interfaces: IEEE-488, and USB. Only one of these interfaces can be active at any time. Use the Interface key to configure the parameters related to the selected interface.

### 4.6.1 USB

The USB interface is provided as a convenient way to connect to most modern computers, as a USB interface is provided on nearly all new PCs as of the writing of this manual. The Model 335 USB driver, which must be installed before using the interface (section 6.3.3), creates a virtual serial com port, which can be used in the same way as a traditional serial com port. Refer to Chapter 6 for details on computer interface operation.

### 4.6.2 IEEE-488

An IEEE 488 (GPIB) interface is provided for compatibility with legacy systems. Refer to Chapter 6 for details on computer interface operation.

#### 4.6.2.1 Remote/Local

Local refers to operating the Model 335 from the front panel. Remote refers to operating the controller via the IEEE 488 Interface. The keypad is disabled during remote operation, except for the **Remote/Local** key and the **ALL OFF** key. When in remote mode the Remote front panel LED will be illuminated. When in local mode, the Remote LED will not be illuminated.

Menu Navigation:

**Remote/Local** (LED On = Remote mode, LED Off = Local mode)

## 4.7 Locking and Unlocking the Keypad

The keypad lock feature prevents accidental changes to parameter values. When the keypad is locked, some parameter values may be viewed, but most cannot be changed from the front panel. **All Off** is the only keypad function that remains active when the keypad is locked.

A three-digit keypad lock code locks and unlocks the keypad. The default code is 123. The code can be changed only through the computer interface. If instrument parameters are reset to default values, the lock code resets also. The instrument cannot reset from the front panel with the keypad locked.

To lock the keypad, press and hold **Enter** for 5 s. Use the numeric keypad to enter the three-digit lock code. If the lock code is accepted, **\*\*\* Keypad Locked \*\*\*** will be displayed for 3 s and the display will return to normal. Changes attempted to any parameters result in a brief display of the **\*\*\* Keypad Locked \*\*\*** message.

To unlock the keypad, press and hold **Enter** for 5 s. Use the numeric keypad to enter the three-digit lock code. If the lock code is accepted, **\*\*\* Keypad Unlocked \*\*\*** will be displayed for 3 s and the display will return to normal. All Model 335 parameters are now accessible.

Interface Command: **LOCK**

# Chapter 5: Advanced Operation

## 5.1 General

This chapter provides information on the advanced operation of the Model 335 temperature controller.

## 5.2 Autotune

The Model 335 can automate the tuning process of typical cryogenic systems with the Autotune feature. For additional information about the algorithm refer to section 2.9.

Before initiating the Autotune process, the cooling system must be configured properly with control input sensor and heater output making it capable of closed-loop control. The control sensor must have a valid temperature response curve assigned to it. An appropriate heater range must also be determined as described in section 2.8.1. The system must be coarsely maintaining temperature within 5 K of the setpoint where new tuning parameters are desired in order for the Autotuning process to initiate. Autotune works only with one control loop at a time and does not set the manual output or heater range.

To initiate the Autotune process, press **Autotune**, then select an Autotune mode. There are three Autotune modes available. They result in slightly different system characteristics. Autotune PI is recommended for most applications.

- **Autotune P:** sets only the P parameter value. I and D are set to 0 no matter what the initial values are. This mode is recommended for systems that have very long lag times or nonlinearity that prevents stable PI control. Expect some overshoot or undershoot of the setpoint and stable temperature control below the setpoint value.
- **Autotune PI:** sets values for both P and I parameters. D is set to 0. This mode is recommended for stable control at a constant temperature. It may take slightly longer to stabilize after setpoint change than Autotune PID. Expect some overshoot or undershoot of the setpoint and stable temperature control at the setpoint value.
- **Autotune PID:** sets values for P, I and D parameters. D is always set to 100%. This mode is recommended when setpoint changes are frequent, but temperature is allowed to stabilize between changes. Stability at setpoint may be worse than Autotune PI in noisy systems. Expect slightly less overshoot or undershoot than the other modes and control at the setpoint value.

When the Autotune process is initiated, a status message will blink over the top of the setpoint and heater output information in the Two Input One Loop display mode and the Input Display mode associated with the control loop being tuned (FIGURE 5-1). This message indicates the status of the Autotune process. For example, if Autotune P is the selected Autotune mode, “Atune Stage: 1 of 7” is displayed when the Autotune process first begins. The status message blinks to indicate that the algorithm is still processing, which also allows the setpoint and heater output information to be monitored during the Autotune process. If an error occurs, the status message stops blinking and displays an error message containing the stage in which Autotune failed.

(FIGURE 5-1). See TABLE 5-1 for a description of the Autotune stages, reasons for failure, and possible solutions. When the process completes successfully, the previous P, I, and D parameters will be replaced by the newly acquired values. The Autotune process can be cancelled by pressing **Autotune** and choosing Yes to the “cancel Autotune” prompt.

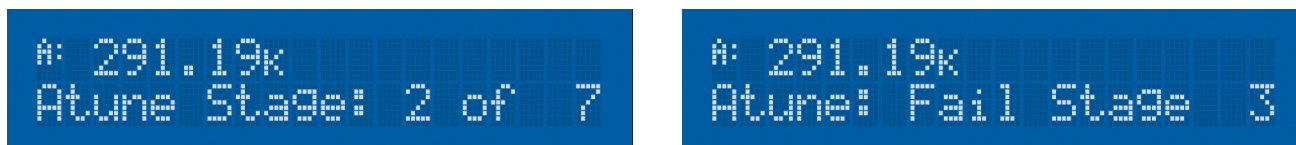

FIGURE 5-1 Left: Example of a screen when Autotune has been initiated. Actual screen will show the message blinking; Right: Autotune error

Stage	Description	Purpose for stage	Reason for failure	Possible solution
0	Testing initial conditions	Determine if Autotuning can be initiated	Curve not assigned to Input, heater not on, or temperature not within 5 K of setpoint	Ensure curve is assigned to input, heater is on, and temperature is within 5 K of setpoint
1	Waiting for temperature to settle	Ensures that temperature is not still settling toward the setpoint, or drifting away from the setpoint	Temperature was moving too much to properly Autotune	Allow the temperature to settle more before initiating Autotune
2	Testing for temperature stability	Ensures that there is no temperature oscillation or excessive noise in the temperature reading	May indicate that the initial P value is too high	Use a smaller initial P value
3	Observing system response to setpoint change	Control parameters are changed based on observation	System response is too slow, or the heater is too underpowered for the system to Autotune	If not already using High range, increase initial heater range
4	Waiting for temperature to settle after returning setpoint to original value	Provides a baseline for subsequent stages	System response is too slow to Autotune, or the new control parameters are causing instability in the control	Use a smaller initial P value
5	Testing for temperature stability	Ensures that there is no temperature oscillation or excessive noise in the temperature reading after control parameter adjustment	System response is too slow to Autotune, or the new control parameters are causing instability in the control	Use a smaller initial P value
6	Observing system response to setpoint change using new control parameters	Control parameters are changed again based on observation; this is the final stage of P-only Autotuning	System response is too slow to Autotune, or the heater is too underpowered for the system to Autotune	If not already using High range, increase initial heater range
7	Waiting for temperature to settle after returning setpoint to original value	Provides a baseline for subsequent stages	System response is too slow to Autotune, or the new control parameters are causing instability in the control	Use a smaller initial P value
8	Testing for temperature stability	Ensures that there is no temperature oscillation or excessive noise in the temperature reading after control parameter adjustment	System response is too slow to Autotune, or the new control parameters are causing instability in the control	Use a smaller initial P value
9	First of two stages of observing system response to setpoint change using new control parameters	Compiles data for characterizing the system	Will not fail in this stage	Not applicable
10	Second of two stages of observing system response to setpoint change using new control parameters	Control parameters are changed again based on observation; this is the final stage of PI and PID Autotuning	System response is too slow, or the heater is too underpowered for the system to Autotune	If not already using High range, increase initial heater range

TABLE 5-1 Autotune stages

Menu Navigation:

**Autotune**→**Input (A, B)**→(Autotune P, Autotune PI, Autotune PID)

Interface Command: **A:TUNE**

## 5.3 Zone Settings

The Model 335 allows you to establish up to ten custom contiguous temperature zones where the controller will automatically use pre-programmed values for PID, heater range, manual output, ramp rate, and control input. Zone control can be active for both control loops at the same time. Configure the zones using 1 as the lowest to 10 as the highest zone. Zone boundaries are always specified in kelvin (K). The bottom of the first zone is always 0 K; therefore, only the upper limit is required for all subsequent zones. Make a copy of FIGURE 5-2 to plan your zones.

To use the programmed zones, the Output mode must be set to Zone (refer to section 4.5.1.6.2 to set up Zone mode). In Zone mode, the instrument will update the control settings each time the setpoint crosses into a new zone. If the settings are changed manually, the controller will use the new setting while it is in the same zone and will update to the programmed zone table settings when the setpoint crosses into a new zone.

The zone settings include a Control Input parameter for each temperature zone. This allows a different feedback sensor to be used for each temperature zone. For example, a diode sensor can be used while cooling down from room temperature to 10 K, at which point the Control Input could be switched to a Cernox™ sensor for temperatures under 10 K. A Control Input parameter of “default” follows the original configuration and does not change the input.

To illustrate how the control parameters are updated in Zone mode, consider the example zone settings in the table below. Starting from room temperature (about 300 K), and setting a setpoint of 2 K (with Setpoint Ramping turned On), the setpoint will begin ramping at the current setpoint Ramp Rate, then once the setpoint crosses 100 K, the control parameters from Zone 7 will be used. The setpoint ramp will then continue toward 2 K at a rate of 20 K/min until crossing 50 K, when the control parameters from Zone 6 are loaded. This pattern will continue until the final setpoint value of 2 K is reached, or another setpoint is entered. Note that Input B will be used in all zones greater than 10 K (zones 4 to 8), and Input A will be used in all zones below 10 K (zones 1 to 3).

Zone	Lower boundary (implied)	Upper boundary	P	I	D	Manual output	Range	Ramp rate	Control input
10	n/a	0 K	50	20	0	0.0%	Off	0.1 K/min	Default
9	n/a	0 K	50	20	0	0.0%	Off	0.1 K/min	Default
8	100.001 K	500 K	200	20	0	0.0%	High	30 K/min	Input B
7	50.001 K	100 K	185	25	0	0.0%	Med	20 K/min	Input B
6	25.001 K	50 K	150	30	0	0.0%	Med	10 K/min	Input B
5	15.001 K	25 K	100	30	0	0.0%	Med	5 K/min	Input B
4	10.001 K	15 K	85	35	0	0.0%	Med	2 K/min	Input B
3	7.001K	10 K	85	35	0	0.0%	Med	0.9 K/min	Input A
2	4.001 K	7 K	70.0	40.0	0	0.0%	Low	0.7 K/min	Input A
1	0 K	4 K	50.0	50.0	0	0.0 %	Low	0.5 K/min	Input A

TABLE 5-2 Zone settings example



**Sensor accuracy and placement will affect how smoothly the transition from one feedback sensor to another is performed. A large difference between the temperature readings of each sensor at the time of transition could cause a temporary instability in the temperature control due to the sudden large error introduced into the control equation.**



**It is highly recommended to use the Setpoint Ramping feature when using the Control Input zone parameter to change sensor inputs. Otherwise a setpoint change may cause a control input sensor to be used outside of its usable range, which will cause an overload condition to shut down the control loop.**



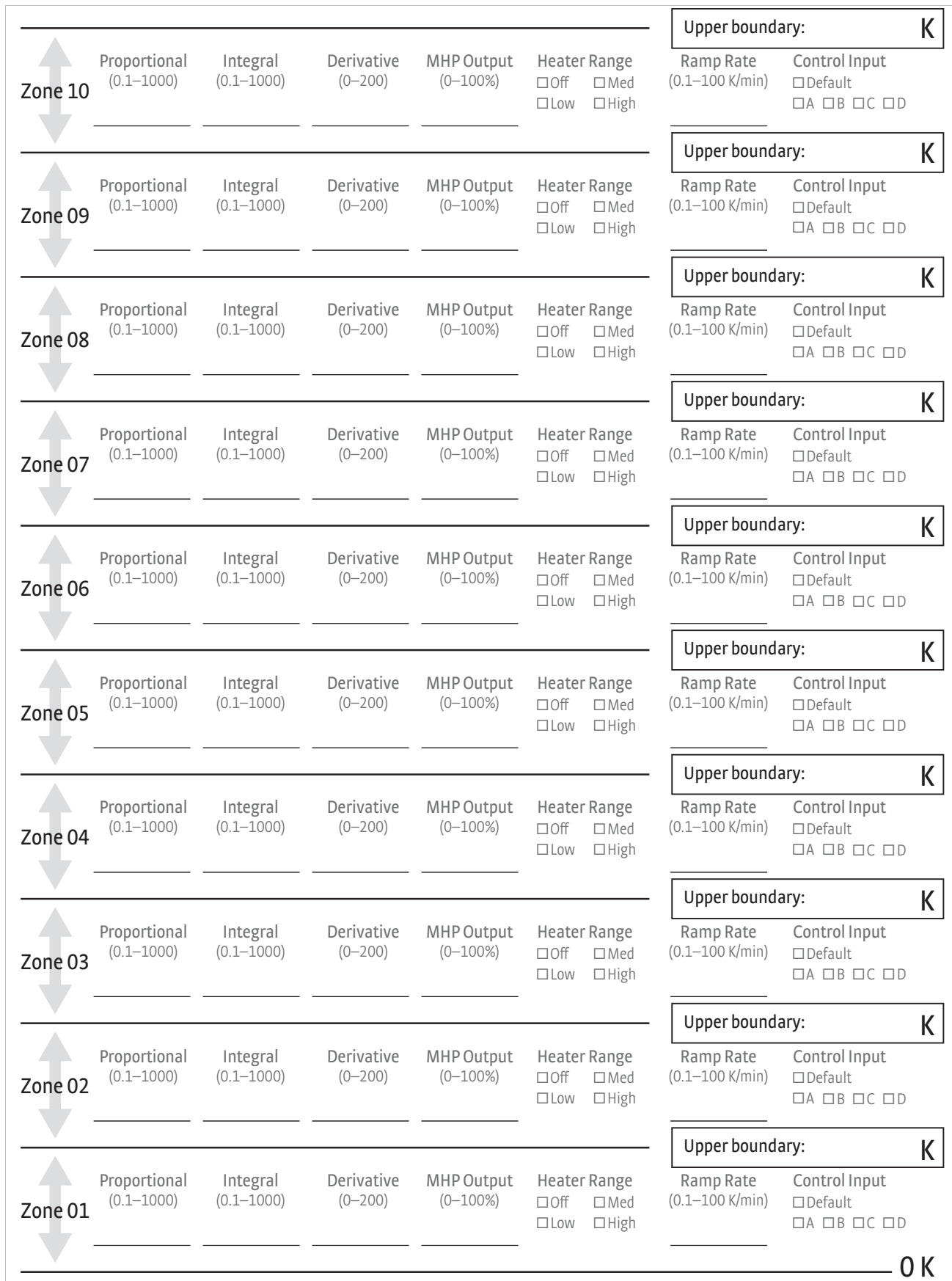

FIGURE 5-2 Record of zone settings

Menu Navigation:

Zone Settings→Output (1, 2)→Zone to edit (1 to 10)

Interface Command: **ZONE**

## 5.4 Bipolar Control

The most common type of temperature control output device is a resistive heater, which requires only unipolar output, since they will add heat regardless of the polarity of the excitation voltage. There are, however, temperature control devices that are bipolar. These devices, such as thermoelectric devices, can work in both polarities, moving heat from one side of the device to the other when a current is applied. Therefore, a surface can be heated or cooled using a bipolar temperature control device. For these types of bipolar devices, the Model 335 features a bipolar control mode. In this mode, the Model 335 is configured to drive these devices to control temperature using Output 2 in Voltage mode. Refer to section 2.11 for more information about thermoelectric devices.

To use Output 2 for bipolar control, first set the Heater Output Type parameter to Voltage, then set the polarity to Bipolar. The Closed Loop PID control mode can then be used to control a thermoelectric device, providing a control output of -10 V to +10 V. Refer to 2.11 for information on thermoelectric devices. Refer to section 3.7.5.4 for information on scaling the output for voltages less than 10 V.

Menu Navigation:

Output Setup→Output 2→Output Type (Voltage)  →Polarity (Bipolar)

Interface Command: **ANALOG**

## 5.5 Warm Up Supply

Warm Up Supply mode is designed for controlling an external power supply used for rapidly increasing the temperature in the controlled system, for example, to bring a system to room temperature in order to change samples. Refer to section 3.7.5 for information on using an external power supply for Warm Up Supply mode.

Warm Up Supply mode is only available when Output 2 is in Voltage mode. The Control Input setting, determines the sensor that is used for feedback in the Warm Up Supply mode. Refer to section 4.5.1.7.1 for details on the Control Input parameter and section 4.5.1 for Output Type.

Once Warm Up Supply mode is configured, use the **Setpoint** key to set the desired temperature, then use the **Heater Range** key to activate the output by setting the range to On. The front panel display must be configured to show the Warm Up control loop for the **Setpoint** and **Heater Range** keys to be used. Refer to section 4.2 and section 4.3 for details on front panel keypad operation and display setup.



**The Power Up Enable feature determines if the output will remain on after power is cycled. Refer to section 4.5.1.4 for details on the Power Up Enable feature.**

Menu Navigation:

Output Setup→Output 2→Output Type (Voltage)→Output Mode (Warm Up Supply)

Interface Command: **OUTMODE**

### 5.5.1 Warm Up Percentage

Use the Warm Up Percentage parameter to determine the voltage amount to apply to the voltage output (Output 2) when using Warm Up mode to control an external power supply. The voltage applied will be the full scale output (+10 V) times the Warm Up Percentage. For example, if the Warm Up Percentage is set to 50%, the control output voltage for the given unpowered output will be 50% of 10 V, or 5 V, when the output is on.

Menu Navigation:

**Output Setup**→Output 2→Output Type (Voltage)→Output Mode (Warm Up Supply)  
→Control Input (A,B) **ENTER** →Warm Up Percentage (0% to 100%)

Default: 100%

Interface Command: **WARMUP**

### 5.5.2 Warm Up Control

The Warm Up Control parameter determines what happens when the control setpoint is reached. The options are:

- **Auto-Off:** once the Heater Range is set to on, the Warm Up Percentage voltage is applied to the output (section 5.5.1) and the output stays on until the control input temperature reaches the control setpoint. The output will then be turned off (0 V), and the Heater Range setting will automatically be set to Off, effectively turning off all temperature control for the control loop. If the Heater Range is again manually set to On, the cycle will begin again, and the output will turn on and stay on until the control input temperature reaches the setpoint again.

Menu Navigation:

**Output Setup**→Output 2→Output Type (Voltage)→Output Mode (Warm Up Supply)→Control Input (A,B) **ENTER** →Warmup Control (Auto-Off)

Interface Command: **WARMUP**

- **Continuous:** this mode implements what is often referred to as On/Off control. Once the Heater Range is set to on, the Warm Up Percentage voltage is applied to the output until the control input temperature reaches the setpoint. Then the output will turn off (0 V) until the temperature falls 1 K below the setpoint, at which point the Warm Up Percentage voltage is again applied to the output. The Heater Range will never be automatically set to Off in this mode.

Menu Navigation:

**Output Setup**→Output 2→Output Type (Voltage)→Output Mode (Warm Up Supply)→Control Input (A,B) **ENTER** →Warmup Control (Continuous)

Default: Continuous

Interface Command: **WARMUP**

## 5.6 Monitor Out

In Monitor Out mode, the voltage output (Output 2) tracks the assigned Control Input according to the scaling parameters you entered. A common use for this function would be to send a voltage proportional to temperature to a data acquisition system. The Control Input parameter setting determines which sensor input is tracked by the output. The remaining parameters detailed in this section dictate how the output value is determined.



**An output configured to Monitor Out mode is not affected by the ALL OFF key, as it does not have a Heater Range setting, and by design is always enabled.**

Menu Navigation:

**Output Setup**→Output 2 →Output Type (Voltage)→Output Mode (Monitor Out)→Control Input (None, Input A, Input B)

Default: Control Input→None

Interface Command: **OUTMODE**

## 5.6.1 Monitor Units

The Monitor Units parameter determines the units of the Control Input sensor to use for creating the proportional voltage output. The Monitor Out scaling parameter settings will be entered using the units chosen for this parameter.

Menu Navigation:

**Output Setup**→Output 2→Output Type (Voltage)→Output Mode (Monitor Out)→Control Input (None, Input A, Input B)→Monitor Out Units (Kelvin, Celsius, or Sensor)

Default: Kelvin

Interface Command: **ANALOG**

### 5.6.1.1 Polarity and Monitor Out Scaling Parameters

In the Monitor Out and Open Loop modes, the voltage output can be configured as either unipolar (0 V to +10 V) or bipolar (−10 V to +10 V). In bipolar mode, the Monitor Out −10 V setting determines the temperature or sensor value at which the output should be −10 V. In unipolar mode, the Monitor Out 0 V setting determines the temperature or sensor value at which the output should be 0 V. The Monitor Out +10 V setting determines the temperature or sensor value at which the output should be +10 V in either unipolar or bipolar modes.

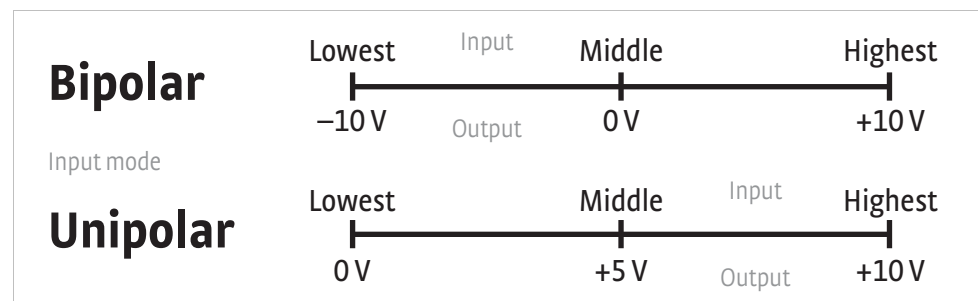

FIGURE 5-3 Unipolar and bipolar mode

For example, if Polarity is set to Bipolar, then setting the Monitor Out −10 V parameter to 0 K and the Monitor Out +10 V parameter to 100 K will cause the voltage output to correspond to the input temperature as shown in FIGURE 5-4. In this case if the actual reading was 50 K, then the output would be at 0 V (middle of the scale).

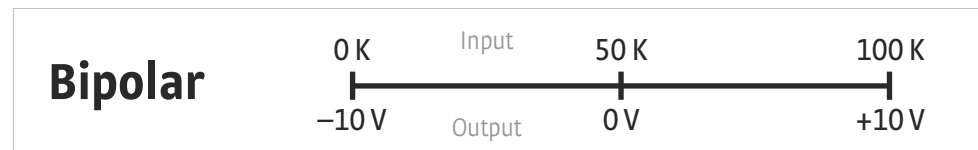

FIGURE 5-4 Analog output with polarity set to bipolar

FIGURE 5-5 shows the output if the Polarity parameter is set to Unipolar. In this case if the actual reading was 50 K, the voltage output would be +5 V (middle of the scale).



FIGURE 5-5 Output with polarity parameter set to unipolar

Menu Navigation:

**Output Setup**→Output 2 →Output Type (Voltage)→Output Mode (Monitor Out)→Control Input (None, Input A, Input B)→Monitor Out Units (Kelvin, Celsius, or Sensor)

**ENTER** →Polarity (Unipolar or Bipolar)

**Output Setup**→Output 2 →Monitor Out 0 V(Unipolar) or -10 V(Bipolar)→(See note below)

**Output Setup**→ Output 2 →Monitor Out +10 V→(See note below)



**Monitor Out settings depend on the Monitor Units selected, and are limited to the acceptable values of the selected units.**

Default:  
*Polarity*→Unipolar  
*Monitor Out 0 V and -10 V*→0.0000 K  
*Monitor Out +10 V*→1000 K  
 Interface Command: **ANALOG**

## 5.7 Alarms and Relays

### 5.7.1 Alarms

Each input of the Model 335 has high and low alarm capability. Input reading data from any source can be compared to the alarm setpoint values. A reading higher than the high alarm setpoint triggers the high alarm for that input. A reading lower than the low alarm setpoint triggers the low alarm for that input.

Menu Navigation:  
 Alarm→Input (A, B)→Alarm (Off, On)  
 Alarm→Input (A, B)→Alarm (On)→Low Setpoint (see note below)  
 Alarm→Input (A, B)→Alarm (On)→ →High Setpoint→(see note below)



**Low and High Setpoint limits are determined by the Preferred Units of the associated sensor input.**

Defaults:  
*Alarm*→Off  
*Low Setpoint*→0.0000 K  
*High Setpoint*→1000 K  
 Interface Command: **ALARM**

#### 5.7.1.1 Alarm Annunciators

The Alarm LED annunciator steadily displays when any alarm that is enabled also has the Visible parameter enabled. The annunciator flashes when an alarm with the Visible parameter enabled activates. An input need not be displayed for the system Alarm annunciator to indicate input alarm status, but if the input is displayed on the front panel, then the reading will alternate between the alarm status message and the actual reading. If the Audible parameter is set to On for an enabled alarm, then the beeper inside the instrument will sound when the alarm activates. The two relays on the Model 335 can also be tied to alarm functions as described in section 5.7.2. You may want to set the Visible parameter to Off if there is no need for showing the alarm state on the front panel, for instance, if you are using the alarm function to trigger a relay. The Audible parameter can be set to Off as well to keep the audible alarm from sounding when an alarm is triggered.

Menu Navigation:  
 Alarm→Input (A, B)→Alarm (On)→ →Visible (Off, On)  
 Alarm→Input (A, B)→Alarm (On)→ →Audible (Off, On)  
 Default:  
*Visible*→On  
*Audible*→On  
 Interface Command: **ALARM**

### 5.7.1.2 Alarm Latching

- **Latching Alarms:** often used to detect faults in a system or experiment that requires operator intervention. The alarm state remains visible to the operator for diagnostics even if the alarm condition is removed. Relays often signal remote monitors, or for added safety take critical equipment off line. Latched alarms can be cleared by pressing **Alarm** and selecting Yes to the Reset Alarm prompt. Select No to the Reset Alarm prompt to enter the Alarm Setup menu.
- **Non-Latching Alarms:** often tied to relay operation to control part of a system or experiment. The alarm state follows the reading value. The dead band parameter can prevent relays from turning on and off repeatedly when the sensor input reading is near an alarm setpoint.

FIGURE 5-6 illustrates the interaction between alarm setpoint and dead band in non-latching operation. With the high alarm setpoint at 100 K and the dead band at 5 K, the high alarm triggers when sensor input temperature increases to 100 K, and it will not deactivate until temperature drops to 95 K. In addition, the same 5 K dead band is applied to the low alarm setpoint as well.

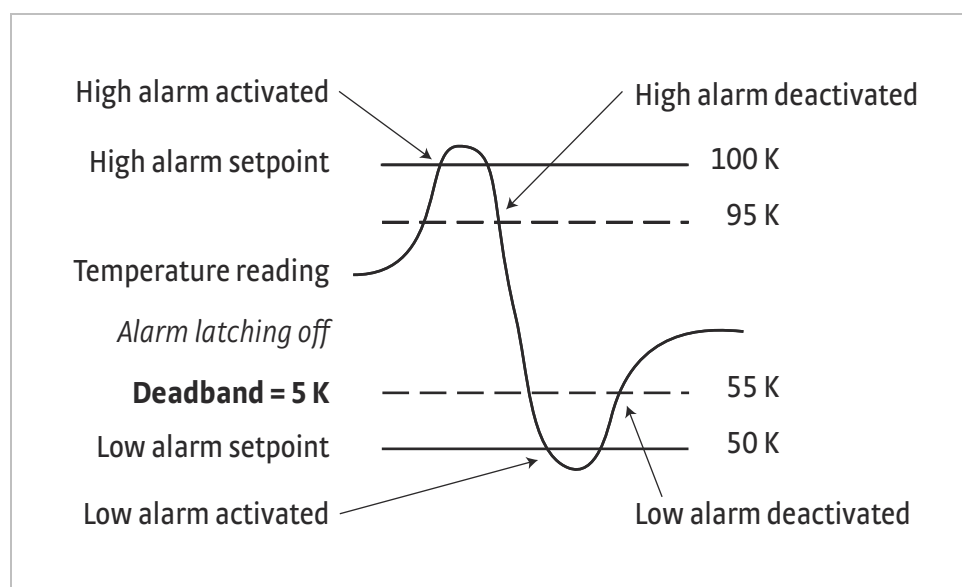

FIGURE 5-6 *Dead band example*

To setup an alarm, enter the Alarm Setup menu by pressing **Alarm**. If a latching alarm has been activated, you will be prompted with a Reset Alarm? message. Select No to enter the Alarm Setup menu.

Menu Navigation:

Alarm→Input (A, B)→Alarm (On)  →Latching (Off, On)

Alarm→Input (A, B)→Alarm (On)  →Deadband (see note below)



**Low and High Setpoint limits are determined by the Preferred Units of the associated sensor input.**

Default:

Latching→Off

Deadband→1.0000 K

Interface Command: **ALARM**

## 5.7.2 Relays

There are two relays on the Model 335 numbered 1 and 2. They are most commonly thought of as alarm relays, but they may be manually controlled also. Relay assignments are configurable as shown in FIGURE 5-7. Two relays can be used with one sensor input for independent high and low operation, or each can be assigned to a different input.

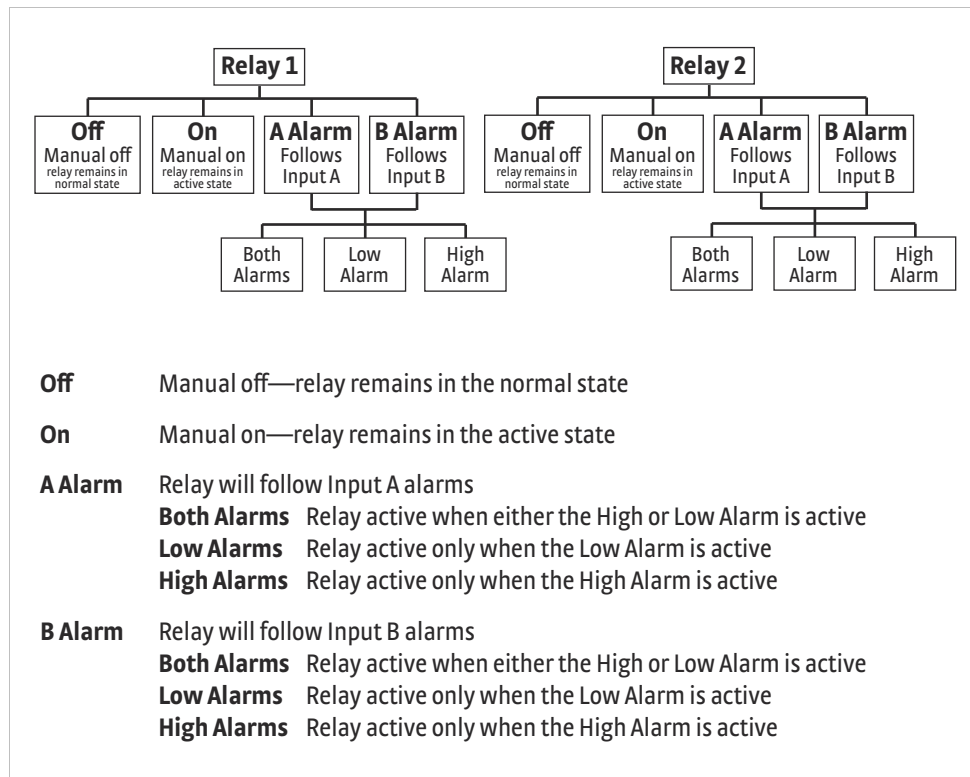

FIGURE 5-7 Relay settings

When using relays with alarm operation, set up alarms first. The relays are rated for 30 VDC and 3 A. Their terminals are in the detachable terminal block on the Model 335 rear panel.

In the Off mode the relay is un-energized, leaving the normally open (NO) contacts open and the normally closed (NC) contacts closed. In the On mode the relay is energized, so the NO contacts will be closed and the NC contacts will be open. In the Alarm mode the relay will activate based on the state of the configured Alarm Input sensor. When the Alarm to Follow parameter is set to Low, the relay will energize if the configured Alarm Input sensor goes into a low alarm state. If it is set to High, the relay will energize if the configured Alarm Input sensor goes into a high alarm state. If the Alarm to Follow parameter is set to Both, the relay will energize if the configured Alarm Input sensor goes into either a low alarm or a high alarm state.

Menu Navigation:

Relays→(Relay 1, Relay 2)→Mode (Off, On, Alarm)

Relays→(Relay 1, Relay 2)→Mode (Alarm)→Alarm Input (Input (A, B))→

Alarm to Follow (Low, High, Both)

Default:

Mode→Off

Alarm Input→Input A

Alarm to Follow→Both

Interface Command: **RELAY**

## 5.8 Curve Numbers and Storage

The Model 335 has 20 standard curve locations, numbered 1 through 20. At present, not all locations are occupied by curves; the others are reserved for future updates. If a standard curve location is in use, the curve can be viewed using the view operation. Standard curves cannot be changed by the user, and reserved locations are not available for user curves.

The Model 335 has 39 user curve locations, numbered 21 through 59. Each location can hold from 2 to 200 data pairs (breakpoints), including a value in sensor units and a corresponding value in kelvin. Using fewer than 200 breakpoints will not increase the number of available curve locations. SoftCal™-generated curves are stored in user curve locations.

### 5.8.1 Curve Header Parameters

Each curve has parameters that are used for identification and to allow the instrument to use the curve effectively. The parameters must be set correctly before a curve can be used for temperature conversion or temperature control.

- **Curve Number:** 1 to 59.
- **Name:** defaults to the name User Curve for front panel entry. A curve name of up to 15 characters can be entered from either the front panel or from the computer interface. Refer to section 4.2.3 for Alpha-Numeric entry.
- **Serial Number:** a sensor serial number of up to ten characters (letters or numbers) can be entered from either the front panel or from the computer interface. Refer to section 4.2.3 for Alpha-Numeric entry. The default is blank.
- **Format:** the format parameter tells the instrument what breakpoint data format to expect. Different sensor types require different formats. Formats for Lake Shore sensors are described in TABLE 5-3.

Format	Description	Sensor units full scale range	Sensor units maximum resolution
V/K	Volts vs. kelvin	10 V	0.00001 V
$\Omega$ /K	Resistance vs. kelvin for platinum RTD sensors	10 K $\Omega$	0.001 $\Omega$
Log $\Omega$ /K	Log resistance vs. kelvin for NTC resistive sensors	4 log $\Omega$	0.00001 log $\Omega$
mV/K	Millivolts vs. kelvin for thermocouple sensors	$\pm$ 100 mV	0.0001 mV

TABLE 5-3 Curve header parameter

- **Setpoint Limit:** limits the control setpoint to values less than or equal to this setting. A setpoint limit can be included with every curve. Default is 375 K. Enter a setting of 9999 K if no limit is needed.
- **Temperature Coefficient:** the temperature coefficient is derived by the Model 335 from the first two breakpoints. The user does not enter this setting. If it is not correct, check for proper entry of the first two breakpoints. A positive coefficient indicates that the sensor signal increases with increasing temperature. A negative coefficient indicates that the sensor signal decreases with increasing temperature.

### 5.8.2 Curve Breakpoints

Temperature response data of a calibrated sensor must be reduced to a table of breakpoints before entering it into the instrument. A curve consists of 2 to 200 breakpoints and each breakpoint consists of one value in sensor units and one temperature value in kelvin. The Model 335 uses linear interpolation to calculate temperature between breakpoints. The instrument will show T.OVER or T.UNDER on the display if the sensor reading is outside the range of the breakpoints. Sensor units are defined by the format setting in TABLE 5-3.



Breakpoint setting resolution is six digits in temperature. Most temperature values are entered with 0.001 resolution. Temperature values of 1000 K and greater can be entered to 0.01 resolution. Temperature values below 10 K can be entered with 0.00001 resolution. Temperature range for curve entry is 0K to 9999.99 K.

Sensor type	Typical Lake Shore model	Format	Limit (K)	Temperature coefficient	Typical sensor resolution
Silicon Diode	DT-670	V/K	475	Negative	0.00001 V
GaAlAs Diode	TG-120	V/K	325	Negative	0.00001 V
Platinum 100	PT-100	$\Omega$ /K	800	Positive	0.001 $\Omega$
Platinum 1000	—*	$\Omega$ /K	800	Positive	0.01 $\Omega$
Rhodium-Iron	RF-800	$\Omega$ /K	325	Positive	0.001 $\Omega$
Carbon-Glass	CGR-1-1000	log $\Omega$ /K	325	Negative	0.00001 log $\Omega$
Cernox™	CX-1050	log $\Omega$ /K	325	Negative	0.00001 log $\Omega$
Germanium	GR-200A-100	log $\Omega$ /K	325	Negative	0.00001 log $\Omega$
Rox™	RX-102A	log $\Omega$ /K	40	Negative	0.00001 log $\Omega$
Type K	9006-005	mV/K	1500	Positive	0.0001 mV
Type E	9006-003	mV/K	930	Positive	0.0001 mV
Type T	9006-007	mV/K	673	Positive	0.0001 mV
Au-Fe 0.03%	—*	mV/K	500	Positive	0.0001 mV
Au-Fe 0.07%	9006-001	mV/K	610	Positive	0.0001 (mV)

\*Not offered by Lake Shore

TABLE 5-4 Typical curve parameters

Setting resolution is also six digits in sensor units. The curve format parameter defines the range and resolution in sensor units as shown in TABLE 5-3. The sensor type determines the practical setting resolution. TABLE 5-4 lists recommended sensor units resolutions.

The breakpoints should be entered with the sensor units value increasing as point number increases. There should not be any breakpoint locations left blank in the middle of a curve. The search routine in the Model 335 interprets a blank breakpoint as the end of the curve.

## 5.9 Front Panel Curve Entry Operations

There are four operations associated with front panel curve entry: Edit Curve, Erase Curve, Copy Curve, and SoftCal, as detailed in TABLE 5-5.

Operation	Description	Refer to section:
Edit Curve	Edit allows the user to view any curve and enter or edit a curve at any user curve location. Standard curves cannot be changed.	5.9.1
Erase Curve	Erase allows the user to delete a curve from any user curve location. Standard curves cannot be erased.	5.9.2
Copy Curve	Copy allows the user to copy a curve from any location to any user curve location. Curves cannot be copied into standard curve locations.	5.9.3
SoftCal	Allows creation of a new temperature curve from a standard curve and known data points entered by the user.	5.10

TABLE 5-5 Front panel curve entry operations

Menu Navigation:

Curve Entry→(Edit, Erase, Copy, SoftCal)

### 5.9.1 Edit Curve

The Edit Curve operation is used to enter a new curve or edit an existing user curve. Only user curves (21 to 59) can be edited. Entering the identification parameters associated with the curve is as important as entering the breakpoints. Curve header parameters are listed in TABLE 5-3. Typical curve parameters for common sensors are listed in TABLE 5-4. Read this section completely and gather all necessary data before beginning the process.



If the curve you wish to enter has similar parameters as an existing curve, first copy the similar curve (as described in Section 5.2.4) to a new location, then edit the curve to the desired parameters.

To perform the Edit Curve operation, follow this procedure:

1. Press **Curve Entry**, scroll to **Edit Curve**, and press **Enter**.
2. Scroll to the desired curve and press **Enter** again.
3. Edit the curve header parameters using the standard keypad operation methods described in section 4.2.3. Once curve header parameters are entered, the Curve Point entry screen is displayed.

The Curve Point entry screen contains a scrollable list of all curve breakpoint pairs in the selected curve. There are three columns in the list. From left to right the columns are: breakpoint number, breakpoint sensor value, and breakpoint temperature value. Initially the highlight is on the first breakpoint number.

Menu Navigation:

**Curve Entry** → **Edit Curve**

Interface Command: **CRVHDR**

#### 5.9.1.1 Edit a Breakpoint Pair

To edit a breakpoint pair, follow this procedure:

1. To select a breakpoint pair to edit, scroll to the desired breakpoint number and press **Enter**. The highlight moves to the sensor value of the selected pair.
2. Use the Number Entry method to edit the value. Refer to section 4.2.1.2 for details on the Number Entry method.
3. Once the new sensor value is entered, press **Enter** to highlight the temperature value. Again use the Number Entry method to enter the new temperature value.
4. Pressing **Enter** at this point will store the new breakpoint pair; pressing **Escape** at any time when a sensor or temperature value is highlighted will cancel any changes to either of the values and return the highlight to the breakpoint number.

If the sensor value entered is not between the previous breakpoint sensor value and the following breakpoint sensor value, then the new breakpoint pair will be moved to the position in the curve that bounds the sensor value of the new breakpoint pair. If the pair is moved, a message will be displayed to indicate the location to which the breakpoint pair was moved.



FIGURE 5-8 *Left: Scroll to highlight a breakpoint number; Middle: Press the enter key to highlight the sensor value of the selected pair; Right: Press the enter key again, and the temperature value is highlighted*

Menu Navigation:

**Curve Entry** → **Edit (21–59)** **[ENTER]** → **Curve Points (1–200)**

Interface Command: **CRVPT**

### 5.9.1.2 Add a New Breakpoint Pair

The last breakpoint of a curve is signified by the first pair that contains a 0 value for both the temperature and sensor portions. Curves are limited to 200 breakpoint pairs, so if 200 pairs already exist, then the 200th pair will be the last pair in the list. To add a new breakpoint pair to a curve that has less than 200 pairs, scroll to the end of the list and edit the 0 value pair by following the procedure for editing a breakpoint pair in section 5.9.1.1. If the curve still contains less than 200 pairs, a new 0 value breakpoint will be added to the end of the list for entering another new breakpoint pair.

Menu Navigation:

Curve Entry → *Edit* (21–59)  → *Curve Points* (1–200)

Interface Command: CRVPT

### 5.9.1.3 Delete a Breakpoint Pair

To delete a breakpoint pair, scroll to the desired breakpoint number, then enter a 0 value for both the sensor and temperature values by following the procedure for editing a breakpoint pair in section 5.9.1.1.



**If you do not enter 0 for both sensor and temperature values, then entering new values over an existing breakpoint pair will replace that pair with the new value when you press the Enter key.**

After editing, adding, or deleting all desired breakpoint pairs, press **Escape** while the highlight is on a breakpoint number. All breakpoint pair changes, additions, and deletions will be saved when exiting the menu.

When curve entry is complete, assign the new curve to an input. The Model 335 does not automatically assign the new curve to any input. Refer to section 4.4.7 for details on assigning a curve to a sensor input.

Menu Navigation:

Curve Entry → *Edit* (21–59)  → *Curve Points* (1– 200)

Interface Command: CRVPT

### 5.9.1.4 Thermocouple Curve Considerations

The following are things to consider when generating thermocouple curves.

- Users may enter temperature response curves for all types of thermocouples. Enter curve data in mV/K format with thermocouple voltage in millivolts and temperature in kelvin.
- The curve must be normalized to 0 mV at 273.15 K (0 °C). Thermocouple voltages in millivolts are positive when temperature is above 273.15 K and negative when temperature is below that point.
- To convert curves published in Celsius to kelvin, add 273.15 to the temperature in Celsius.
- The input voltage of the Model 335 is limited to  $\pm 50$  mV, so any part of the curve that extends beyond  $\pm 50$  mV is not usable by the instrument.
- A message of S.OVER or S.UNDER on the display indicates that the measured thermocouple input is over or under the  $\pm 50$  mV range.

## 5.9.2 Erase Curve

User curves that are no longer needed may be erased. Erase Curve sets all identification parameters to default and blanks all breakpoint values. To perform the Erase Curve operation, follow this procedure:

1. Press **Curve Entry**, scroll to Erase Curve, and press **Enter**.
2. Scroll to the desired curve and press **Enter**.
3. Choose Yes at the confirmation message to finalize the operation.
4. To cancel the operation, either choose No to the confirmation message, or press **Escape**.

Menu Navigation:

**Curve Entry** → *Erase Curve (21–59)* → *Delete Curve #?* (Yes, No)

Interface Command: **CRDEL**

## 5.9.3 Copy Curve

Temperature curves can be copied from one location inside the Model 335 to another. This is a good way to make small changes to an existing curve. Curve copy may also be necessary if the user needs the same curve with two different temperature limits or needs to extend the range of a standard curve. The curve that is copied from is always preserved.



**The copy routine allows you to overwrite an existing user curve. Please ensure the curve number you are writing to is correct before proceeding with the copy curve operation.**

To perform the Copy Curve operation, follow this procedure:

1. Press **Curve Entry**, scroll to Copy Curve, and press **Enter**.
2. Scroll to the desired curve to copy and press **Enter**. Scroll to the desired user curve location to copy to, and press **Enter**.
3. Choose Yes at the confirmation message to finalize the operation.
4. To cancel the operation, either choose No to the confirmation message, or press **Escape**.

Menu Navigation:

**Curve Entry** → *Copy Curve* → Copy Curve from (1 to 59) → Copy Curve to (21 to 59)

Interface Command: (No interface command directly corresponds to the copy curve operation. The CRVHDR and CRVPT commands can be used to read curve information from one curve location and write that information to another curve location.)

## 5.10 SoftCal™

The Model 335 allows you to perform inexpensive sensor calibrations with a set of algorithms called SoftCal™. The two SoftCal™ algorithms in the Model 335 work with DT-400 Series silicon diode sensors and platinum sensors. They create a new temperature response curve from the standard curve and known data points entered by the user. The new curve loads into one of the user curve locations (21 to 59) in the instrument. The following sections describe the data points needed from the user and the expected accuracy of the resulting curves.



**A feature similar to SoftCal™ is available for compensating thermocouples using the Curve Handler program.**

Both DT-400 Series and platinum SoftCal™ algorithms require a standard curve that is already present in the Model 335. When you enter the type of sensor being calibrated, select the correct standard curve. When calibration is complete, assign the new curve to an input. The Model 335 does not automatically assign the newly generated curve to either input.

Calibration data points must be entered into the Model 335. These calibration points are normally measured at easily obtained temperatures like the boiling point of cryogenes. Each algorithm operates with one, two, or three calibration points. The range of improved accuracy increases with more points.

There are two ways to get SoftCal™ calibration data points: you can record the response of an unknown sensor at well controlled temperatures, or you can purchase a SoftCal™ calibrated sensor from Lake Shore. There are advantages to both methods.

- *User:* when you can provide stable calibration temperatures with the sensor installed, SoftCal™ calibration eliminates errors in the sensor measurement as well as the sensor. Thermal gradients, instrument accuracy, and other measurement errors can be significant to some users. Calibration can be no better than user-supplied data.
- *Purchased:* Lake Shore sensors with SoftCal™ calibration include a set of calibration points in the calibration report. The SoftCal™ calibration points are generated in a controlled calibration facility at Lake Shore for best accuracy. The calibration points can be entered into the Model 335 so it can generate a curve. If the CalCurve™ service is purchased with the calibrated sensor, the curve is also generated at the factory and can be entered like any other curve.

### 5.10.1 SoftCal™ with Silicon Diode Sensors

Lake Shore silicon diode sensors incorporate remarkably uniform sensing elements that exhibit precise, monotonic, and repeatable temperature response. For example, the Lake Shore DT-400 Series of silicon diode sensors have a repeatable temperature response from 2 K to 475 K. These sensors closely follow a standard curve. SoftCal™ is an inexpensive way to improve the accuracy of an already predictable sensor.

A unique characteristic of DT-400 Series diodes is that their temperature responses pass through 28 K at almost exactly the same voltage. This improves SoftCal™ algorithm operation by providing an extra calibration data point. It also explains why SoftCal™ calibration specifications are divided into two temperature ranges, above and below 28 K. See FIGURE 5-9.

- *Point one:* calibration data point at or near the boiling point of helium, 4.2 K. Acceptable temperature entries are 2 K to 10 K. This data point improves between the calibration data point and 28 K. Points two and three improve temperatures above 28 K.
- *Point two:* calibration data point at or near the boiling point of nitrogen (77.35 K). Temperatures outside 50 K to 100 K are not allowed. This data point improves accuracy between 28 K and 100 K. Points two and three together improve accuracy to room temperature and above.
- *Point three:* calibration data point near room temperature (305 K). Temperatures outside the range of 200 K to 350 K are not allowed.

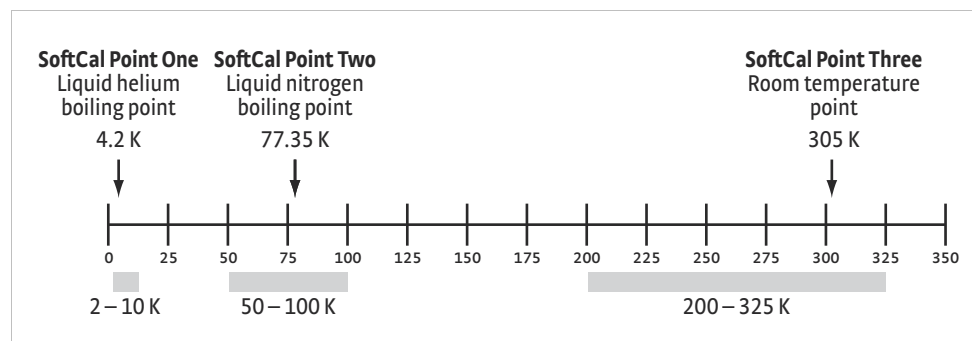

FIGURE 5-9 Acceptable temperature range for DT-400 series silicon diode SoftCal™ sensors

### 5.10.2 SoftCal™ Accuracy with DT-400 Series Silicon Diode Sensors

A SoftCal™ calibration is only as good as the accuracy of the calibration points. The accuracies listed for SoftCal™ assume  $\pm 0.01$  K for 4.2 K (liquid helium),  $\pm 0.05$  K for 77.35 K (liquid nitrogen), and 305 K (room temperature) points. If you are performing the SoftCal™ with Lake Shore instruments, note that the boiling point of liquid cryogen, though accurate, is affected by atmospheric pressure. Use calibrated standard sensors if possible.

One-point SoftCal™ calibrations for applications under 30 K are performed at liquid helium (4.2 K) temperature. Accuracy for the DT-470-SD-13 diode is  $\pm 0.5$  K from 2 K to  $<30$  K with no accuracy change above 30 K.

Two-point SoftCal™ calibrations for applications above 30 K are performed at liquid nitrogen (77.35 K) and room temperature (305 K). Accuracy for the DT-470-SD-13 diode sensor is as follows:

$\pm 1.0$ K	2 K to $<30$ K (no change below 30 K)
$\pm 0.25$ K	30 K to $<60$ K
$\pm 0.15$ K	60 K to $<345$ K
$\pm 0.25$ K	345 K to $<375$ K
$\pm 1.0$ K	375 to 475 K

TABLE 5-6 Two-point SoftCal™ calibration accuracy for DT-470-SD-13 diode sensors

Three-point SoftCal™ calibrations are performed at liquid helium (4.2 K), liquid nitrogen (77.35 K), and room temperature (305 K). Accuracy for the DT-470-SD-13 diode sensor is as follows:

$\pm 0.5$ K	2 K to $<30$ K
$\pm 0.25$ K	30 K to $<60$ K
$\pm 0.15$ K	60 K to $<345$ K
$\pm 0.25$ K	345 K to $<375$ K
$\pm 1.0$ K	375 to 475 K

TABLE 5-7 Three-point SoftCal™ calibration accuracy for DT-470-SD-13 diode sensors

### 5.10.3 SoftCal™ With Platinum Sensors

The platinum sensor is a well-accepted temperature standard because of its consistent and repeatable temperature response above 30 K. SoftCal™ gives platinum sensors better accuracy than their nominal matching to the DIN 43760 curve.

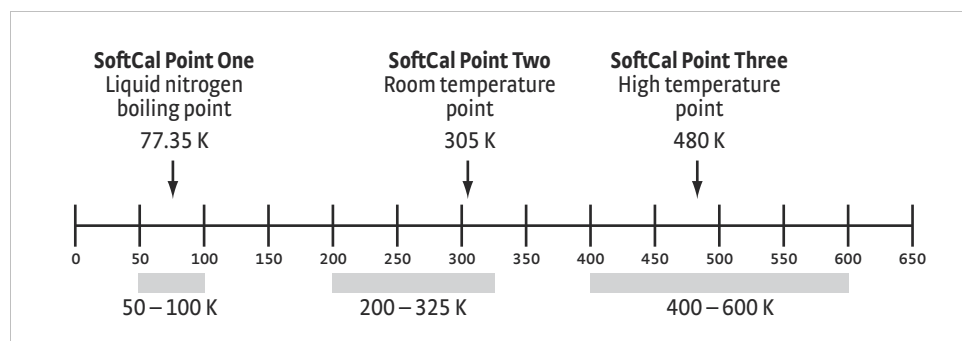

FIGURE 5-10 Acceptable temperature range for platinum SoftCal™ sensors

One, two, or three calibration data points can be used. If you are using one point, the algorithm shifts the entire curve up or down to meet the single point. If you are using two points, the algorithm has enough information to tilt the curve, achieving good accuracy between the data points. The third point extends the improved accuracy to span all three points.

- *Point one:* calibration data point at or near the boiling point of nitrogen (77.35 K). Acceptable temperature entries are 50 K to 100 K.
- *Point two:* calibration data point near room temperature (305 K). Acceptable temperature entries are 200 K to 300 K.
- *Point three:* calibration data point at a higher temperature (480 K). Acceptable temperature entries are 400 K to 600 K.

#### 5.10.4 SoftCal™ Accuracy With Platinum Sensors

A SoftCal™ calibration is only as good as the accuracy of the calibration points. The accuracies listed for SoftCal™ assume  $\pm 0.05$  K for 77.35 K (liquid nitrogen) and 305 K (room temperature) points. If you are performing the SoftCal™ with Lake Shore instruments, note that the boiling point of liquid cryogen, though accurate, is affected by atmospheric pressure. Use calibrated standard sensors if possible.

One-point SoftCal™ calibrations with platinum sensors have no specified accuracy.

Two-point SoftCal™ calibrations for applications above 70 K are performed at liquid nitrogen (77.35 K) and room temperature (305 K). Accuracy for the PT-102, PT-103, or PT-111 platinum sensor is as follows:

<b>±250 mK</b>	70 K to 325 K
<b>±500 mK</b>	325 K to ±1400 mK at 480 K

(DIN class A or class B tolerance)

TABLE 5-8 *Three-point SoftCal™ calibration accuracy for DT-470-SD-13 diode sensors*

Three-point SoftCal™ calibrations are performed at liquid nitrogen (77.35 K), room temperature (305 K), and high temperature (480 K). Accuracy for the PT-102, PT-103, or PT-111 platinum sensor is  $\pm 250$  mK from 70 K to 325 K, and  $\pm 250$  mK from 325 K to 480 K.

#### 5.10.5 SoftCal™ Calibration Curve Creation

Once the calibration data points have been obtained, you may create a SoftCal™ calibration. To create a SoftCal™ calibration, use this procedure:

1. Press **Curve Entry**, then scroll to SoftCal and press **Enter**.
2. A list of sensor types is displayed containing DT-470, PT-100, and PT 1000. Scroll to the desired sensor type and press **Enter**.
3. Use the Store Curve To prompt to choose the user curve location in which to store the newly generated curve.
4. If desired, use the Serial Number parameter to enter a serial number for the newly generated curve.
5. Use the Point X Temp and Point X Sensor parameters to enter calibration data for point X, where X can be point one, two, or three. If only one or two data points were acquired, only enter those data points and leave the others at their default values.



**Review the acceptable temperature ranges for each calibration data point in FIGURE 5-9 and FIGURE 5-10. If a temperature value outside of the acceptable range is entered, the value will be limited to the closest acceptable value.**

6. Once the data points are entered, select yes at the Generate SoftCal prompt and press **Enter**.
7. To cancel the operation, either choose No to the Generate SoftCal prompt, or press **Escape**.



**The Generate Softcal operation will overwrite an existing user curve. Please ensure the curve number you are writing to is correct before generating the calibrated curve.**



You can check the new curve using the Edit Curve instructions in section 5.9.2. The curve is not automatically assigned to any input, so you will need to assign the new curve to an input. Refer to section 4.4.7 for details on assigning a curve to a sensor input.

Menu Navigation:

Curve Entry → Select Function → Softcal (DT-470, Platinum 100, Platinum 1000) → Data Entry (see note below) → (Generate Softcal) (Yes)

Interface Command: **SCAL**



**Data entry includes user curve location, new curve serial number, and calibration points.**

## 5.11 Emulation Modes

To provide compatibility with pre-existing software that was written to work with a Model 331 or a Model 332, the Model 335 can be configured to emulate the remote interface of these previous model temperature controllers. These emulation modes allow a Model 335 to replace a Model 331 or Model 332 in a software controlled system with very little effort, and very little downtime.

### 5.11.1 Emulation Mode Configuration

To assist in the ease of replacing a Model 331 or a Model 332 with a Model 335, certain hardware settings are automatically configured when the Emulation mode is set to Model 331 or Model 332.

Both emulation modes will trigger the heater resistance setting on Output 1 to be configured to the 50  $\Omega$  setting, which will also limit the max current setting to 1 A. This setting matches the hardware capabilities of the previous model temperature controllers.

The Model 331 Emulation mode will trigger the output type setting for Output 2 to be configured to Voltage, because the voltage output on the Model 335 exactly matches the hardware capabilities of the Loop 2 output on the Model 331.

The Model 332 emulation mode will trigger the output type setting for Output 2 to be configured to Current. This does not provide an exact match of the Model 332 hardware, as the Loop 2 output on the Model 332 is actually a  $\pm 10$  V voltage source output. However, the maximum current draw of 1 A on Loop 2 of the Model 332 is reached at full scale output when using a 10  $\Omega$  heater, providing 10 W of heater power, and the Output 2 current source on the Model 335 is also capable of providing 1 A of current into a 10  $\Omega$  heater at full scale. So applications using a 10  $\Omega$  heater on Output 2 will work the same using a Model 335 in current mode as they did when using the Model 332.



**The settings that are automatically configured can be changed manually after configuring the Emulation mode if so desired.**

The PID Scaling mode and baud rate settings are not automatically configured when the Emulation mode is configured to Model 331 or Model 332. These settings must be manually configured to meet your application needs. Note that the PID Scaling mode and baud rate will be returned to the default state, and will not be configurable, when the Emulation mode is set to None. Refer to section 5.11.4 for information on the PID Scaling mode, and section 5.11.5 for information on the Baud Rate setting.



### 5.11.2 Unsupported Commands

Some commands are not supported in the Model 335, regardless of the emulation mode, as the associated functions are no longer included. Although these commands are unsupported, a properly formatted reply will be sent when these queries are received to prevent locking up or crashing software that was written to query this information. These unsupported commands are:

- LDAT
- LINEAR
- MNMX

Except for the unsupported commands above, when the Model 335 is in the proper emulation mode, it will interpret all Model 331 and Model 332 commands. Each command will either be interpreted directly, or it will be translated to the most appropriate Model 335 setting, for full compatibility with the Model 331 or the Model 332. Some settings will not directly apply to the Model 335, such as the Auto-tune control modes. Attempts to set an inapplicable setting will be ignored.

### 5.11.3 Command Interpretation

As a reference, the following commands are interpreted differently depending on the emulation mode setting:

- HTR
- HTRST
- RANGE
- ANALOG
- DISPFLD
- IEEE
- TUNEST
- INTYPE
- ZONE

The Model 335 must be configured to the appropriate emulation mode in order for the commands to be interpreted correctly.

### 5.11.4 PID Scaling Mode

The PID Scaling mode determines whether the Model 335 emulates the control scaling of the Model 331 and Model 332. In the Model 331 and Model 332, temperature control is calculated using sensor units. Sensor units can cause the control response to be non-linear across temperature ranges if the sensor's temperature response curve is non-linear. Using units of temperature in the PID control algorithm allows the control response to be linear throughout all temperatures, leaving only the non-linearities in the system to require new PID values. Therefore, we recommend that you set the PID Scaling mode to 335.

Menu Navigation:

Interface **ENTER** → *Emulation Mode* (Model 331, Model 332) **ENTER** → *PID Scaling* (335, 331/332)

Interface Command: **EMUL**

### 5.11.5 Baud Rate

Models 331 and 332 only supported baud rates of 300, 1200, and 9600. When not configured for Model 331 or Model 332 emulation, the Model 335 only supports a baud rate of 57600. However, in Model 331 or Model 332 Emulation mode, the baud rate setting becomes available for configuring values of 300, 1200, 9600, or 57600. When changing the Emulation mode back to None, the baud rate setting is returned to the Model 335 default, and the non-configurable value of 57600.

Menu Navigation:

Interface **ENTER** → *Emulation Mode* (Model 331, Model 332) **ENTER** → *Baud Rate* (57600, 9600, 1200, 300)

Interface Command: **BAUD**

## 5.11.6 Hardware Differences

One of the most significant hardware differences between the Model 335, Model 331 and Model 332 is the Loop 2, or Output 2, control output. The Model 331 provides a  $\pm 10$  V voltage source output with 100 mA maximum current, providing 1 W into a  $100 \Omega$  heater. The Model 332 provides a  $\pm 10$  V voltage source output with 1 A maximum current, providing up to 10 W into a  $10 \Omega$  heater. The Model 335 provides both a  $\pm 10$  V voltage source with 100 mA maximum current, which is the exact same hardware as the Model 331, and a +1 A current source, which can be used to emulate the Loop 2 output of the Model 332 into a  $10 \Omega$  heater (TABLE 5-9 provides a summary of these differences).

	Controller	Output 2 type	Voltage source output	Maximum current	Power
331 Emulation Mode	Model 331	Voltage	$\pm 10$ V	100 mA	1 W into $100 \Omega$
	Model 335	Voltage	$\pm 10$ V	100 mA	1 W into $100 \Omega$
332 Emulation Mode	Model 332	Voltage	$\pm 10$ V	1 A	10 W into $10 \Omega$
	Model 335	Current	+35.4 V	1 A (configurable)	10 W into $10 \Omega$

TABLE 5-9 Output 2 hardware comparisons between Models 331, 332, and 335

For Output 2 of the Model 335, the factory default Output Type setting is Current, but either output type can be used in any emulation mode. Therefore when setting the emulation mode from the front panel, the user is also prompted to set the Output Type for Output 2. In most cases the Voltage setting is more appropriate for Model 331 emulation, and the Current setting is more appropriate for Model 332 emulation, but the user must determine the appropriate setting for the given system.

### CAUTION

The Output 2 current source is NOT limited to +10 V, and is capable of providing more than 25 W of power, depending on the heater resistance. When using the current source for Output 2, ensure that the power rating of the attached heater will not be exceeded given the maximum current of 1 A. See section 2.5.1 for information on limiting the maximum current for the current source outputs, which can be used to limit the amount of power into the attached heater.

### NOTE

The Current and Voltage outputs use separate physical rear panel connections. See section 4.5.1 for information on the Output Type setting.

Menu Navigation:

Interface  $\overline{\text{ENTER}}$  → Emulation Mode (None, Model 331, Model 332)

Interface Command: **EMUL**

## 5.11.7 Emulation Mode Differences

The only difference between the Model 331 Emulation mode and the Model 332 Emulation mode is in the interpretation of the INTYPE command. The Model 332 Emulation mode interprets Sensor Type parameter settings of 8 through 12 as the NTC RTD ranges that are exclusive to the Model 332. The Model 331 Emulation mode interprets Sensor Type parameter settings of 8 and 9 as the alternate 1mA Diode current excitation range.



# Chapter 6: Computer Interface Operation

## 6.1 General

This chapter provides operational instructions for the computer interface for the Lake Shore Model 335 temperature controller. Both of the computer interfaces provided with the Model 335 permit remote operation. The first is the IEEE-488 interface described in section 6.2. The second is the USB interface described in section 6.3. The two interfaces share a common set of commands detailed in section 6.4. Only one of the interfaces can be used at a time.

## 6.2 IEEE-488 Interface

The IEEE-488 interface is an instrumentation bus with hardware and programming standards that simplify instrument interfacing. The Model 335 IEEE-488 interface complies with the IEEE-488.2 standard and incorporates its functional, electrical, and mechanical specifications unless otherwise specified in this manual.

All instruments on the interface bus perform one or more of the interface functions of Talker, Listener, or Bus Controller. A Talker transmits data onto the bus to other devices. A Listener receives data from other devices through the bus. The Bus Controller designates to the devices on the bus which function to perform. The Model 335 performs the functions of Talker and Listener, but it cannot be a Bus Controller. The Bus Controller is the digital computer that tells the Model 335 which functions to perform.

TABLE 6-1 defines the IEEE-488 capabilities and subsets for the Model 335:

Subset	Capabilities
SH1	Source handshake capability
RL1	Complete remote/local capability
DC1	Full device clear capability
DT0	No device trigger capability
CO	No system controller capability
T5	Basic Talker, serial poll capability, talk only, unaddressed to talk if addressed to listen
L4	Basic Listener, unaddressed to listen if addressed to talk
SR1	Service request capability
AH1	Acceptor handshake capability
PP0	No parallel poll capability
E1	Open collector electronics

TABLE 6-1 Model 335 IEEE-488 interface capabilities and their subsets

Instruments are connected to the IEEE-488 bus by a 24-conductor connector cable as specified by the standard (section 8.10.1). Cables can be ordered from Lake Shore as IEEE-488 Cable Kit 4005, or they can be purchased from other electronic suppliers.

Cable lengths are limited to 2 m (6.6 ft) for each device and 20 m (65.6 ft) for the entire bus. The Model 335 can drive a bus with up to ten loads. If more instruments or cable length is required, a bus expander must be used.

### 6.2.1 Changing IEEE-488 Interface Parameters

The IEEE-488 address must be set from the front panel before communication with the instrument can be established.

Menu Navigation:

Interface→Enabled→IEEE-488

Interface→IEEE-488 Address→(1 to 31)

Default: IEEE-488

### 6.2.2 Remote/Local Operation

Normal operations from the keypad are referred to as local operations. The Model 335 can also be configured for remote operations via the IEEE-488 interface or the **Remote/Local** key. The **Remote/Local** key will toggle between remote and local operation. During remote operations, the remote annunciator LED will be illuminated, and operations from the keypad will be disabled.

### 6.2.3 IEEE-488.2 Command Structure

The Model 335 supports several command types. These commands are divided into four groups.

1. Bus Control (section 6.2.3.1).
  - a. Universal
    - Uniline
    - Multiline
  - b. Addressed bus control
2. Common (section 6.2.3.2).
3. Device Specific (section 6.2.3.3).
4. Message Strings (section 6.2.3.4).

#### 6.2.3.1 Bus Control Commands

A bus control command can either be a universal or an addressed bus control. A universal command addresses all devices on the bus. Universal commands include uniline and multiline commands. A uniline command (message) asserts only a single signal line. The Model 335 recognizes two of these messages from the Bus Controller: Remote (REN) and Interface Clear (IFC). The Model 335 sends one uniline command: Service Request (SRQ).

- REN (Remote): puts the Model 335 into remote mode
- IFC (Interface Clear): stops current operation on the bus
- SRQ (Service Request): tells the bus controller that the Model 335 needs interface service

A multiline command asserts a group of signal lines. All devices equipped to implement such commands do so simultaneously upon command transmission. These commands transmit with the Attention (ATN) line asserted low. The Model 335 recognizes two multiline commands:

- LLO (Local Lockout): prevents the use of instrument front panel controls
- DCL (Device Clear): clears Model 335 interface activity and puts it into a bus idle state

Finally, addressed bus control commands are multiline commands that must include the Model 335 listen address before the instrument responds. Only the addressed device responds to these commands. The Model 335 recognizes three of the addressed bus control commands:

- SDC (Selective Device Clear): the SDC command performs essentially the same function as the DCL command, except that only the addressed device responds
- GTL (Go To Local): the GTL command is used to remove instruments from the remote mode. With some instruments, GTL also unlocks front panel controls if they were previously locked out with the LLO command.

- SPE (Serial Poll Enable) and SPD (Serial Poll Disable): serial polling accesses the Service Request Status Byte Register. This status register contains important operational information from the unit requesting service. The SPD command ends the polling sequence.

### 6.2.3.2 Common Commands

Common commands are addressed commands that create commonality between instruments on the bus. All instruments that comply with the IEEE-488 standard share these commands and their format. Common commands all begin with an asterisk. They generally relate to bus and instrument status and identification. Common query commands end with a question mark (?). Model 335 common commands are detailed in section 6.4.1 and summarized in TABLE 6-6.

### 6.2.3.3 Device Specific Commands

Device-specific commands are addressed commands. The Model 335 supports a variety of device specific commands to program instruments remotely from a digital computer and to transfer measurements to the computer. Most device specific commands also work if performed from the front panel. Model 335 device specific commands are detailed in section 6.4.1 and summarized in TABLE 6-6.

### 6.2.3.4 Message Strings

A message string is a group of characters assembled to perform an interface function. There are three types of message strings: commands, queries and responses. The computer issues command and query strings through user programs, and the instrument issues responses. Two or more command strings or queries can be chained together in one communication, but they must be separated by a semi-colon (;). The total communication string must not exceed 255 characters in length.

A command string is issued by the computer and instructs the instrument to perform a function or change a parameter setting. When a command is issued, the computer is acting as talker and the instrument as listener. The format is:

```
<command mnemonic><space><parameter data><terminator>.
```

Command mnemonics and parameter data necessary for each command is described in section 6.4.1. A terminator must be sent with every message string.

A query string is issued by the computer and instructs the instrument which response to send. Queries are issued similar to commands, with the computer acting as talker and the instrument as listener. The query format is:

```
<query mnemonic><?><space><parameter data><terminator>.
```

Query mnemonics are often the same as commands with the addition of a question mark. Parameter data is often unnecessary when sending queries. Query mnemonics and parameter data (if necessary) is described in section 6.4.1. A terminator must be sent with every message string. Issuing a query does not initiate a response from the instrument.

A response string is sent by the instrument only when it is addressed as a talker and the computer becomes the listener. The instrument will respond only to the last query it receives. The response can be a reading value, status report or the present value of a parameter. Response data formats are listed along with the associated queries in section 6.4.1.

## 6.2.4 Status System Overview

The Model 335 implements a status system compliant to the IEEE-488.2 standard. The status system provides a method of recording and reporting instrument information and is typically used to control the Service Request (SRQ) interrupt line. A diagram of the status system is shown in FIGURE 6-1. The status system is made up of status register sets, the Status Byte register, and the Service Request Enable register. Each register set consists of three types of registers: condition, event, and enable.

### 6.2.4.1 Condition Registers

Each register set (except the Standard Event Register set) includes a condition register as shown in FIGURE 6-1. The condition register constantly monitors the instrument status. The data bits are real-time and are not latched or buffered. The register is read-only.

### 6.2.4.2 Event Registers

Each register set includes an event register as shown in FIGURE 6-1. Bits in the event register correspond to various system events and latch when the event occurs. When an event bit is set, subsequent events corresponding to that bit are ignored. Set bits remain latched until the register is cleared by a query command (such as \*ESR?) or a \*CLS command. The register is read-only.

### 6.2.4.3 Enable Registers

Each register set includes an enable register as shown in FIGURE 6-1. An enable register determines which bits in the corresponding event register will set the summary bit for the register set in the Status Byte. The user may write to or read from an enable register. Each event register bit is logically ANDed to the corresponding enable bit of the enable register. When an enable register bit is set by the user, and the corresponding bit is set in the event register, the output (summary) of the register will be set, which in turn sets the summary bit of the Status Byte register.

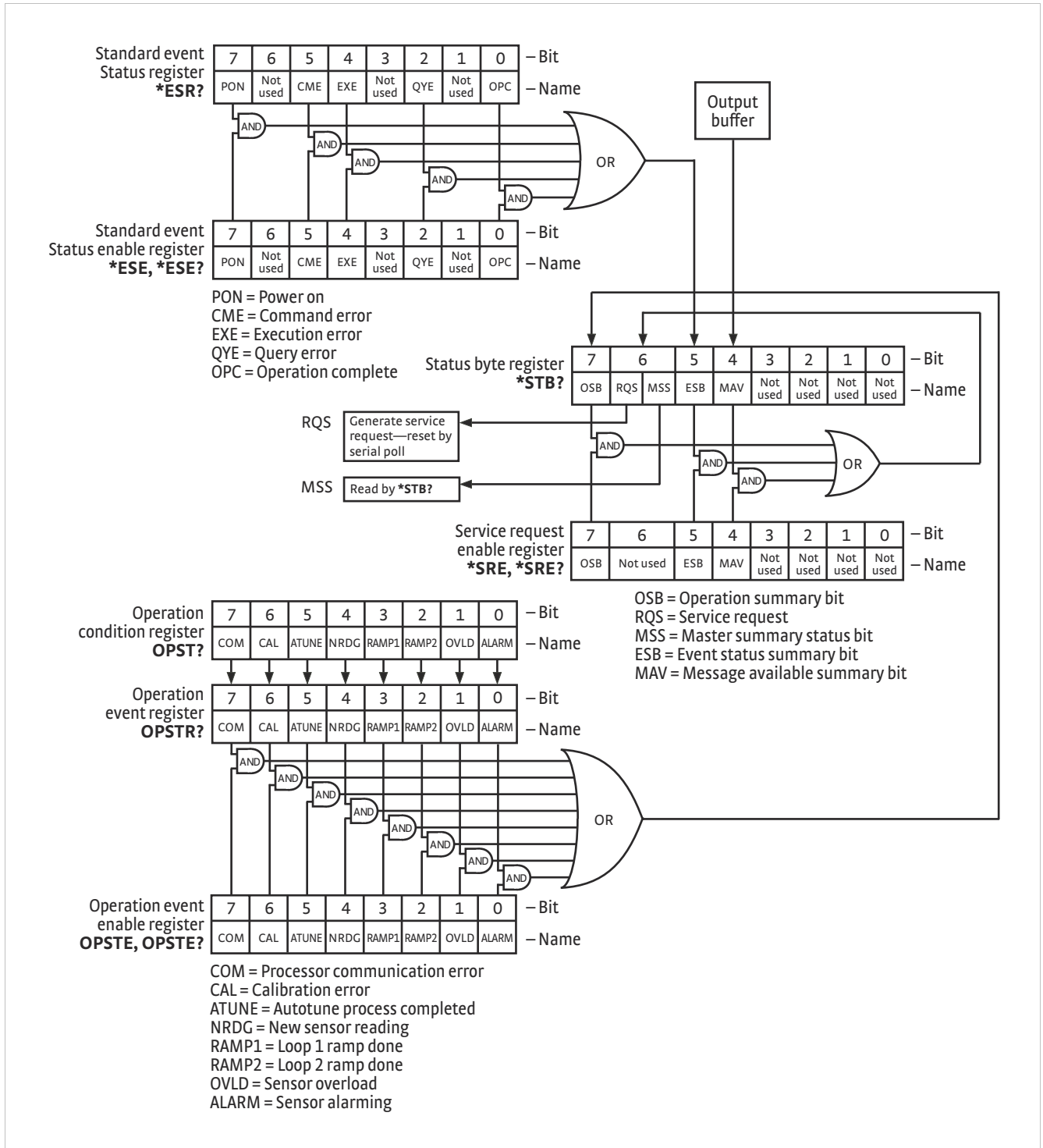

FIGURE 6-1 Model 335 status system



#### 6.2.4.4 Status Byte Register

The Status Byte register, typically referred to as the Status Byte, is a non-latching, read-only register that contains all of the summary bits from the register sets. The status of the summary bits are controlled from the register sets as explained in section 6.2.4.1 to section 6.2.4.3. The Status Byte also contains the Request for Service (RQS)/Master Summary Status (MSS) bit. This bit is used to control the Service Request hardware line on the bus and to report if any of the summary bits are set via the \*STB? command. The status of the RQS/MSS bit is controlled by the summary bits and the Service Request Enable Register.

#### 6.2.4.5 Service Request Enable Register

The Service Request Enable Register determines which summary bits in the Status Byte will set the RQS/MSS bit of the Status Byte. The user may write to or read from the Service Request Enable Register. Each Status Byte summary bit is logically ANDed to the corresponding enable bit of the Service Request Enable Register. When a Service Request Enable Register bit is set by the user, and the corresponding summary bit is set in the Status Byte, the RQS/MSS bit of the Status Byte will be set, which in turn sets the Service Request hardware line on the bus.

#### 6.2.4.6 Reading Registers

Any register in the status system may be read using the appropriate query command. Some registers clear when read, others do not (section 6.2.4.8). The response to a query will be a decimal value that corresponds to the binary-weighted sum of all bits in the register (TABLE 6-2). The actual query commands are described later throughout section 6.4.1.

Position	B7	B6	B5	B4	B3	B2	B1	B0
Decimal	128	64	32	16	8	4	2	1
Weighting	$2^7$	$2^6$	$2^5$	$2^4$	$2^3$	$2^2$	$2^1$	$2^0$

*Example: If bits 0, 2, and 4 are set, a query of the register will return a decimal value of 21 ( $1+4+16$ ).*

TABLE 6-2 Binary weighting of an 8-bit register

#### 6.2.4.7 Programming Registers

The only registers that may be programmed by the user are the enable registers. All other registers in the status system are read-only registers. To program an enable register, send a decimal value that corresponds to the desired binary-weighted sum of all bits in the register (TABLE 6-2). The actual commands are described throughout (section 6.4.1).

### 6.2.4.8 Clearing Registers

The methods to clear each register are detailed in TABLE 6-3.

Register	Method	Example
Condition registers	None: registers are not latched	—
Event registers: Standard event status register Operation event register	Query the event register	*ESR? (clears Standard Event Status Register)
	Send *CLS	*CLS (clears both registers)
	Power on instrument	—
Enable registers: Standard Event Status Enable Register Operation Event Enable Register Service Request Enable Register	Write 0 to the enable register	*ESE 0 (clears Standard Event Status Enable register)
	Power on instrument	—
Status byte	There are no commands that directly clear the status byte as the bits are non-latching; to clear individual summary bits clear the event register that corresponds to the summary bit; sending *CLS will clear all event registers which in turn clears the status byte	If bit 5 (ESB) of the status byte is set, send *ESR? to read the standard event status register and bit 5 will clear
	Power on instrument	—

TABLE 6-3 Register clear methods

## 6.2.5 Status System Detail: Status Register Sets

As shown in FIGURE 6-1, there are two register sets in the status system of the Model 335: Standard Event Status Register and Operation Event Register.

### 6.2.5.1 Standard Event Status Register Set

The Standard Event Status Register reports the following interface related instrument events: power on detected, command syntax errors, command execution errors, query errors, operation complete. Any or all of these events may be reported in the standard event summary bit through the enable register (FIGURE 6-2). The Standard Event Status Enable command (\*ESE) programs the enable register and the query command (\*ESE?) reads it. \*ESR? reads and clears the Standard Event Status Register. The used bits of the Standard Event Register are described as follows:

- Power On (PON), Bit (7): this bit is set to indicate an instrument off-on transition.
- Command Error (CME), Bit (5): this bit is set if a command error has been detected since the last reading. This means that the instrument could not interpret the command due to a syntax error, an unrecognized header, unrecognized terminators, or an unsupported command.
- Execution Error (EXE), Bit (4): this bit is set if an execution error has been detected. This occurs when the instrument is instructed to do something not within its capabilities.
- Query Error (QYE), Bit (2): this bit indicates a query error. It occurs rarely and involves loss of data because the output queue is full.
- Operation Complete (OPC), Bit (0): when \*OPC is sent, this bit will be set when the instrument has completed all pending operations. The operation of this bit is not related to the \*OPC? command, which is a separate interface feature (section 6.2.6.6).

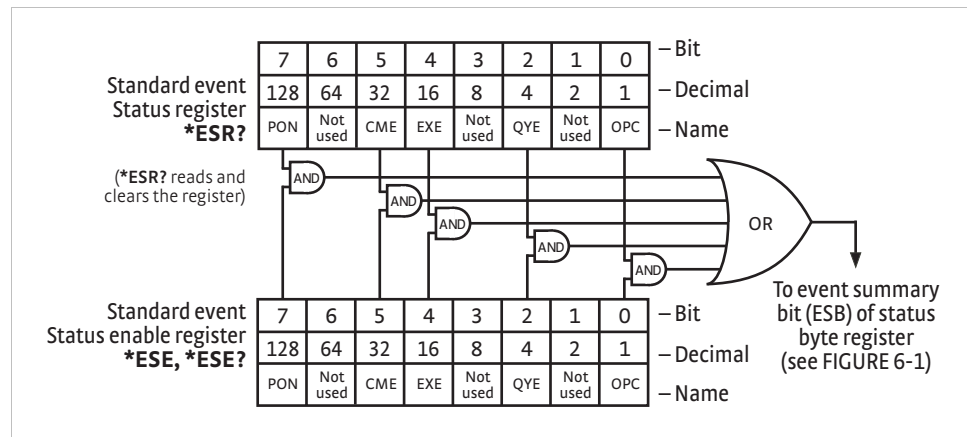

FIGURE 6-2 Standard event status register

### 6.2.5.2 Operation Event Register Set

The Operation Event Register reports the interface related instrument events listed below. Any or all of these events may be reported in the operation event summary bit through the enable register (FIGURE 6-3). The Operation Event Enable command (OPSTE) programs the enable register and the query command (OPSTE?) reads it. OPSTR? reads and clears the Operation Event Register. OPST? reads the Operation Condition register. The used bits of the Operation Event Register are described as follows:

- Processor Communication Error (COM), Bit (7): this bit is set when the main processor cannot communicate with the sensor input processor
- Calibration Error (CAL), Bit (6): this bit is set if the instrument is not calibrated or the calibration data has been corrupted
- Autotune Done (ATUNE), Bit (5): this bit is set when the Autotuning algorithm is NOT active
- New Sensor Reading (NRDG), Bit (4): this bit is set when there is a new sensor reading
- Loop 1 Ramp Done (RAMP1), Bit (3): this bit is set when a loop 1 setpoint ramp is completed
- Loop 2 Ramp Done (RAMP2), Bit (2): this bit is set when a loop 2 setpoint ramp is completed
- Sensor Overload (OVL), Bit (1): this bit is set when a sensor reading is in the overload condition
- Alarming (ALARM), Bit (0): this bit is set when an input is in an alarming state, and the Alarm Visible parameter is on

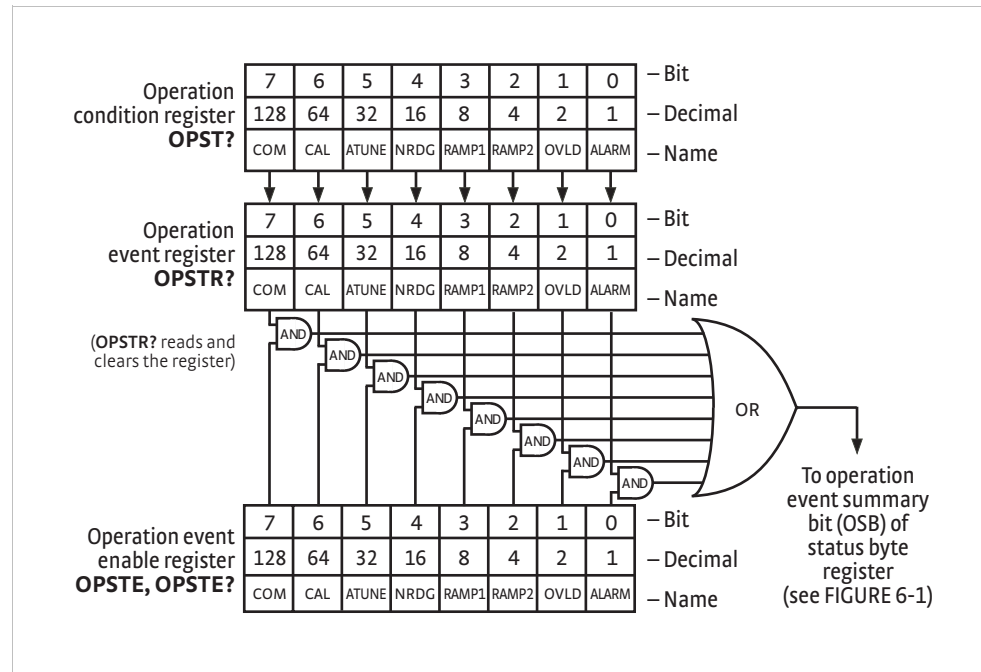

FIGURE 6-3 Operation event register

## 6.2.6 Status System Detail: Status Byte Register and Service Request

As shown in FIGURE 6-1, the Status Byte Register receives the summary bits from the two status register sets and the message available summary bit from the output buffer. The status byte is used to generate a service request (SRQ). The selection of summary bits that will generate an SRQ is controlled by the Service Request Enable Register.

### 6.2.6.1 Status Byte Register

The summary messages from the event registers and the output buffer set or clear the summary bits of the Status Byte Register (FIGURE 6-4). These summary bits are not latched. Clearing an event register will clear the corresponding summary bit in the Status Byte Register. Reading all messages in the output buffer, including any pending queries, will clear the message available bit. The bits of the Status Byte Register are described as follows:

- **Operation Summary (OSB), Bit (7)**: this bit is set when an enabled operation event has occurred
- **Request Service (RQS)/Master Summary Status (MSS), Bit (6)**: this bit is set when a summary bit and the summary bit's corresponding enable bit in the Service Request Enable Register are set. Once set, the user may read and clear the bit in two different ways, which is why it is referred to as both the RQS and the MSS bit. When this bit goes from low to high, the Service Request hardware line on the bus is set; this is the RQS function of the bit (section 6.2.6.3). In addition, the status of the bit may be read with the \*STB? query, which returns the binary weighted sum of all bits in the Status Byte; this is the MSS function of the bit.

Performing a serial poll will automatically clear the RQS function, but it will not clear the MSS function. A \*STB? will read the status of the MSS bit (along with all of the summary bits), but also will not clear it. To clear the MSS bit, either clear the event register that set the summary bit or disable the summary bit in the Service Request Enable Register.

- Event Summary (ESB), Bit (5): this bit is set when an enabled standard event has occurred
- Message Available (MAV), Bit (4): this bit is set when a message is available in the output buffer

### 6.2.6.2 Service Request Enable Register

The Service Request Enable Register is programmed by the user and determines which summary bits of the Status Byte may set bit 6 (RQS/MSS) to generate a Service Request. Enable bits are logically ANDed with the corresponding summary bits (FIGURE 6-4). Whenever a summary bit is set by an event register and its corresponding enable bit is set by the user, bit 6 will set to generate a service request. The Service Request Enable command (\*SRE) programs the Service Request Enable Register and the query command (\*SRE?) reads it.

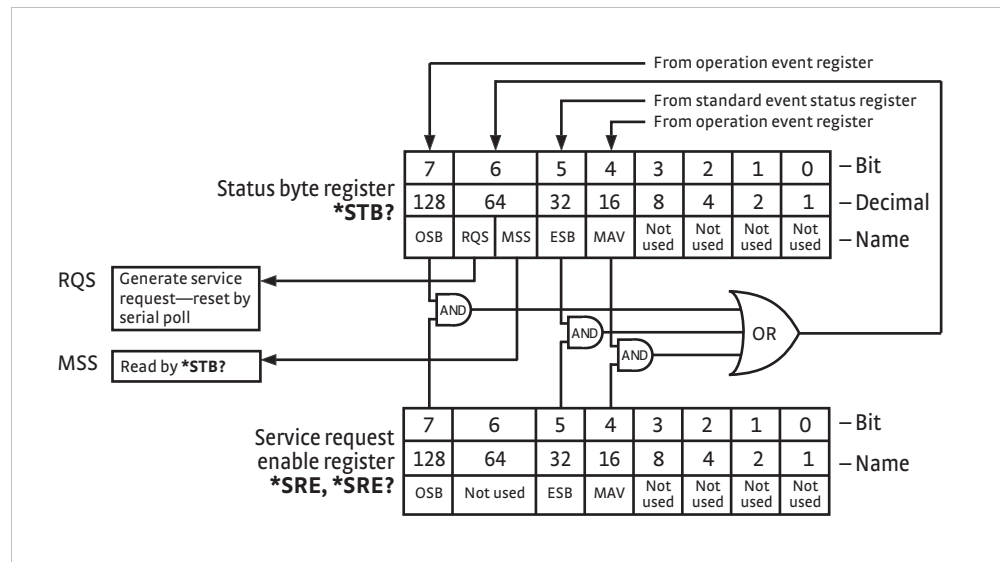

FIGURE 6-4 Status byte register and service request enable register

### 6.2.6.3 Using Service Request (SRQ) and Serial Poll

When a Status Byte summary bit (or MAV bit) is enabled by the Service Request Enable Register and goes from 0 to 1, bit 6 (RQS/MSS) of the status byte will be set. This will send a service request (SRQ) interrupt message to the bus controller. The user program may then direct the bus controller to serial poll the instruments on the bus to identify which one requested service (the one with bit 6 set in its status byte).

Serial polling will automatically clear RQS of the Status Byte Register. This allows subsequent serial polls to monitor bit 6 for an SRQ occurrence generated by other event types. After a serial poll, the same event or any event that uses the same Status Byte summary bit, will not cause another SRQ unless the event register that caused the first SRQ has been cleared, typically by a query of the event register.

The serial poll does not clear MSS. The MSS bit stays set until all enabled Status Byte summary bits are cleared, typically by a query of the associated event register (section 6.2.6.4).

The programming example in TABLE 6-4 initiates an SRQ when a command error is detected by the instrument.

Command or Operation	Description
*ESR?	Read and clear the Standard Event Status Register
*ESE 32	Enable the Command Error (CME) bit in the Standard Event Status Register
*SRE 32	Enable the Event Summary Bit (ESB) to set the RQS
*ABC	Send improper command to instrument to generate a command error
Monitor bus	Monitor the bus until the Service Request interrupt (SRQ) is sent.
Initiate serial poll	Serial poll the bus to determine which instrument sent the interrupt and clear the RQS bit in the Status Byte.
*ESR?	Read and clear the Standard Event Status Register allowing an SRQ to be generated on another command error.

TABLE 6-4 Programming example to generate an SRQ

#### 6.2.6.4 Using Status Byte Query (\*STB?)

The Status Byte Query (\*STB?) command is similar to a serial poll except it is processed like any other instrument command. The \*STB? command returns the same result as a serial poll except that the Status Byte bit 6 (RQS/MSS) is not cleared. In this case, bit 6 is considered the MSS bit. Using the \*STB? command does not clear any bits in the Status Byte Register.

#### 6.2.6.5 Using the Message Available (MAV) Bit

Status Byte summary bit 4 (MAV) indicates that data is available to read into the bus controller. This message may be used to synchronize information exchange with the bus controller. The bus controller can, for example, send a query command to the Model 335 and then wait for MAV to set. If the MAV bit has been enabled to initiate an SRQ, the user's program can direct the bus controller to look for the SRQ leaving the bus available for other use. The MAV bit will be clear whenever the output buffer is empty.

#### 6.2.6.6 Using Operation Complete (\*OPC) and Operation Complete Query (\*OPC?)

The Operation Complete (\*OPC) and Operation Complete Query (\*OPC?) are both used to indicate when pending device operations complete. However, the commands operate with two distinct methods.

The \*OPC command is used in conjunction with bit 0 (OPC) of the Standard Event Status Register. If \*OPC is sent as the last command in a command sequence, bit 0 will be set when the instrument completes the operation that was initiated by the command sequence. Additional commands may be sent between the instrument and the bus controller while waiting for the initial pending operation to complete. A typical use of this function would be to enable the OPC bit to generate an SRQ and include the \*OPC command when programming the instrument. The bus controller could then be instructed to look for an SRQ allowing additional communication with the instrument while the initial process executes.

The \*OPC? query has no interaction with bit 0 (OPC) of the Standard Event Status Register. If the \*OPC? query is sent at the end of a command sequence, the bus will be held until the instrument completes the operation that was initiated by the command sequence. Additional commands (except \*RST) should not be sent until the operation is complete, as erratic operation will occur. Once the sequence is complete a 1 will be placed in the output buffer. This function is typically used to signal a completed operation without monitoring the SRQ. It is also used when it is important to prevent any additional communication on the bus during a pending operation.

## 6.3 USB Interface

The Model 335 USB interface provides a convenient way to connect to most modern computers, as a USB interface is provided on nearly all new PCs as of the writing of this manual. The USB interface is implemented as a virtual serial com port connection. This implementation provides a simple migration path for modifying existing RS-232 based remote interface software. It also provides a simpler means of communicating than a standard USB implementation.

### 6.3.1 Physical Connection

The Model 335 has a B-type USB connector on the rear panel. This is the standard connector used on USB peripheral devices, and it allows the common USB A-type to B-type cable to be used to connect the Model 335 to a host PC. The pin assignments for A-type and B-type connectors are shown in section 8.10. The maximum length of a USB cable, as defined by the USB 2.0 standard, is 5 m (16.4 ft). This length can be extended using USB hubs every 5 m (16.4 ft) up to 5 times, for a maximum total length of 30 m (98.4 ft).

### 6.3.2 Hardware Support

The USB interface emulates an RS-232 serial port at a fixed 57,600 baud rate, but with the physical connections of a USB. This programming interface requires a certain configuration to communicate properly with the Model 335. The proper configuration parameters are listed in TABLE 6-5.

<b>Baud rate</b>	57,600
<b>Data bits</b>	7
<b>Start bits</b>	1
<b>Stop bits</b>	1
<b>Parity</b>	Odd
<b>Flow control</b>	None
<b>Handshaking</b>	None

TABLE 6-5 *Host com port configuration*

The USB hardware connection uses the full speed (12,000,000 bits/s) profile of the USB 2.0 standard; however, since the interface uses a virtual serial com port at a fixed data rate, the data throughput is still limited to a baud rate of 57,600 bits/s.

### 6.3.3 Installing the USB Driver

The Model 335 USB driver has been made available through Windows® Update. This is the recommended method for installing the driver, as it will ensure that you always have the latest version of the driver installed. If you are unable to install the driver from Windows® Update, refer to section 6.3.3.3 to install the driver from the web or from the disc provided with the Model 335.

These procedures assume that you are logged into a user account that has administrator privileges.

#### 6.3.3.1 Installing the Driver From Windows® Update in Windows Vista® or Windows 7

1. Connect the USB cable from the Model 335 to the computer.
2. Turn on the Model 335.
3. When the Found New Hardware wizard appears, select **Locate and install driver software (recommended)**.
4. If User Account Control(UAC) is enabled, a UAC dialog box may appear asking if you want to continue. Click **Continue**.
5. The Found New Hardware wizard should automatically connect to Windows® Update and install the drivers.



If the Found New Hardware wizard is unable to connect to Windows® Update or find the drivers, a message to “Insert the disc that came with your Lake Shore Model 335” will be displayed. Click Cancel and refer to section 6.3.3.3 to install the driver from the web.

- When the Found New Hardware wizard finishes installing the driver, a confirmation message stating “the software for this device has been successfully installed” will appear. Click Close to complete the installation.

#### 6.3.3.2 Installing the Driver From Windows® Update in Windows® XP

- Connect the USB cable from the Model 335 to the computer.
- Turn on the Model 335.
- When the Found New Hardware wizard appears, select **Yes, this time only** and click **Next**.
- Select **Install the software automatically (Recommended)** and click **Next**.
- The Found New Hardware wizard should automatically connect to Windows® Update and install the drivers.



If the Found New Hardware wizard is unable to connect to Windows® Update or find the drivers, a message saying **Cannot Install this Hardware** will be displayed. Click the **Cancel** button and refer to section 6.3.3.3 to install the driver from the web.

- When the Found New Hardware wizard finishes installing the driver a confirmation message stating “the wizard has finished installing the software for Lake Shore Model 335 Temperature Controller” will appear. Click **Finish** to complete the installation.

#### 6.3.3.3 Installing the Driver From the Web

The Model 335 USB driver is available on the Lake Shore website. To install the driver it must be downloaded from the website and extracted. Use the procedure in section 6.3.3.1 through section 6.3.3.4 to download, extract, and install the driver using Windows Vista®, Windows 7, and XP.

##### 6.3.3.3.1 Download the driver:

- Locate the Model 335 USB driver on the downloads page on the Lake Shore website.
- Right-click on the USB driver download link, and select **save target/link as**.
- Save the driver to a convenient place, and take note as to where the driver was downloaded.

##### 6.3.3.3.2 Extract the driver:

The downloaded driver is in a ZIP compressed archive. The driver must be extracted from this file. Windows® provides built-in support for ZIP archives. If this support is disabled, a third-party application, such as WinZip™ or 7-Zip, must be used.

For Windows Vista® or Windows 7:

- Right click on the file and click **extract all**.
- An Extract Compressed (Zipped) Folders dialog box will appear. It is recommended the default folder is not changed. Take note of this folder location.
- Click to clear the **Show extracted files when complete** checkbox, and click **Extract**.

For Windows® XP

- Right-click on the file and click **extract all**.
- The Extraction wizard will appear. Click **Next**.



3. It is recommended the default folder is not changed. Take note of this folder location and click **Next**.
4. An "Extraction complete" message will be displayed. Click to clear the **Show extracted files** checkbox, and click **Finish**.

#### 6.3.3.3 Manually install the driver

Manually installing drivers differ between versions of Windows®. The following sections describe how to manually install the driver using Windows Vista®, Windows 7, and XP. To install the driver you must be logged into a user account that has administrator privileges.

For Windows Vista® or Windows 7

1. Connect the USB cable from the Model 335 to the computer.
2. Turn on the Model 335.
3. If the Found New Hardware wizard appears, click **Ask me again later**.
4. Open Device Manager. Use this procedure to open Device Manager.
  - a. Click the Windows® **Start** button and type Device Manager in the **Start Search** box.
  - b. Click on the Device Manager link in the Search Results Under Programs dialog box.
  - c. If User Account Control is enabled click **Continue** on the User Account Control prompt.
5. Click **View** and ensure the **Devices by Type** check box is selected.
6. In the main window of Device Manager, locate **Other Devices** in the list of device types. In many instances this will be between Network adapters and Ports (COM & LPT). If the **Other Devices** item is not already expanded, click the + icon. Lake Shore Model 335 should appear indented underneath **Other Devices**. If it is not displayed as Lake Shore Model 335, it might be displayed as USB Device. If neither are displayed, click **Action** and then **Scan for hardware changes**, which may open the Found New Hardware wizard automatically. If the Found New Hardware wizard opens, click **Cancel**.
7. Right-click on Lake Shore Model 335 and click **Update Driver Software**.
8. Click **Browse my computer for driver software**.
9. Click **Browse** and select the location of the extracted driver.
10. Ensure the **Include subfolders** check box is selected and click **Next**.
11. When the driver finishes installing a confirmation message stating "Windows has successfully updated your driver software" should appear. Click **Close** to complete the installation.

For Windows® XP

1. Connect the USB cable from the Model 335 to the computer.
2. Turn on the Model 335.
3. The Found New Hardware wizard should appear. If the Found New Hardware wizard does not appear, the following procedure can be used to open the Hardware Update wizard which can be used instead:
  - a. Open Device Manager. Use this procedure to open the Device Manager:
    - Right-click on **My Computer** and then click **Properties**. This will open the System Properties dialog.
    - Click the **Hardware** tab and then click **Device Manager**.
  - b. Click **View** and ensure the **Devices by Type** check box is selected.

- c. In the main window of Device Manager, locate the **Ports (COM & LPT)** device type. In many instances this will be between the Network adapters and Processors items. If the **Ports (COM & LPT)** item is not already expanded, click the + icon. Lake Shore Model 335 should appear indented underneath **Ports (COM & LPT)**. If it is not displayed as Lake Shore Model 335, it might be displayed as USB Device. If neither are displayed, click **Action** and then select **Scan for hardware changes**, which may open the Found New Hardware wizard automatically. If the Found New Hardware wizard opens, continue to step 4.
  - d. Right-click on Lake Shore Model 335 and click **Update Driver**.
4. Select **No, not at this time** and click **Next**.
  5. Select **Search for the best driver in these locations**, click to clear the **Search removable media (floppy, CD-ROM...)** check box, and click the **Include this location in the search** check box.
  6. Click **Browse** and open the location of the extracted driver.
  7. Click **Next**.
  8. When the driver finishes installing a confirmation message stating “The wizard has finished installing the software for Lake Shore Model 335 Temperature Controller” should appear. Click **Finish** to complete the installation.

#### 6.3.3.4 Installing the USB Driver from the Included CD

The Model 335 USB driver is available on the included CD. The following section describes the process of installing the driver from the CD. To install the driver you must be logged into a user account that has administrator privileges.

For Windows Vista® or Windows 7

1. Insert the CD into the computer.
2. Follow steps 1–9 of the Windows Vista® or Windows 7 procedure in section 6.3.3.3.
3. Click **Browse** and select the drive containing the included CD.
4. Ensure the **Include subfolders** check box is selected and click **Next**.
5. When the driver finishes installing a confirmation message stating “Windows has successfully updated your driver software” should appear. Click **Close** to complete the installation.

For Windows® XP

1. Insert the CD into the computer.
2. Connect the USB cable from the Model 335 to the computer.
3. Turn on the Model 335.
4. When the Found New Hardware wizard appears select **No, not at this time** and click **Next**.
5. Select **Install the software automatically (recommended)** and click **Next**.
6. The Found New Hardware wizard should automatically search the CD and install the drivers.
7. When the Found New Hardware Wizard finishes installing the drivers a message stating "the wizard has finished installing the software for Lake Shore Model 335 Temperature Controller" should appear. Click **Finish** to complete the installation.

## 6.3.4 Communication

Communicating via the USB interface is done using message strings. The message strings should be carefully formulated by the user program according to some simple rules to establish effective message flow control.

### 6.3.4.1 Character Format

A character is the smallest piece of information that can be transmitted by the interface. Each character is ten bits long and contains data bits, bits for character timing, and an error detection bit. The instrument uses 7 bits for data in the American Standard Code for Information Interchange (ASCII) format. One start bit and one stop bit are necessary to synchronize consecutive characters. Parity is a method of error detection. One parity bit configured for odd parity is included in each character.

ASCII letter and number characters are used most often as character data. Punctuation characters are used as delimiters to separate different commands or pieces of data. A special ASCII character, line feed (LF OAH), is used to indicate the end of a message string. This is called the message terminator. The Model 335 will accept either the line feed character alone, or a carriage return (CR ODH) followed by a line feed as the message terminator. The instrument query response terminator will include both carriage return and line feed.

### 6.3.4.2 Message Strings

A message string is a group of characters assembled to perform an interface function. There are three types of message strings: commands, queries and responses. The computer issues command and query strings through user programs, the instrument issues responses. Two or more command or query strings can be chained together in one communication, but they must be separated by a semi-colon (;). The total communication string must not exceed 255 characters in length.

A command string is issued by the computer and instructs the instrument to perform a function or change a parameter setting. The format is:

```
<command mnemonic><space><parameter data><terminators>.
```

Command mnemonics and parameter data necessary for each one is described in section 6.4. Terminators must be sent with every message string.

A query string is issued by the computer and instructs the instrument to send a response. The query format is:

```
<query mnemonic><?><space><parameter data><terminators>.
```

Query mnemonics are often the same as commands with the addition of a question mark. Parameter data is often unnecessary when sending queries. Query mnemonics and parameter data if necessary is described in section 6.4. Terminators must be sent with every message string. The computer should expect a response very soon after a query is sent.

A response string is the instrument's response or answer to a query string. The response can be a reading value, status report or the present value of a parameter. Response data formats are listed along with the associated queries in section 6.4. The response is sent as soon as possible after the instrument receives the query.

## 6.3.5 Message Flow Control

It is important to remember that the user program is in charge of the USB communication at all times. The instrument cannot initiate communication, determine which device should be transmitting at a given time, or guarantee timing between messages. All of this is the responsibility of the user program.

When issuing commands the user program alone should:

- Properly format and transmit the command including the terminator as one string
- Guarantee that no other communication is started for 50 ms after the last character is transmitted
- Not initiate communication more than 20 times/s

When issuing queries or queries and commands together, the user program should:

- Properly format and transmit the query including the terminator as one string
- Prepare to receive a response immediately
- Receive the entire response from the instrument including the terminator
- Guarantee that no other communication is started during the response or for 50 ms after it completes
- Not initiate communication more than 20 times/s

Failure to follow these simple rules will result in inability to establish communication with the instrument or intermittent failures in communication.

## 6.4 Command Summary

This section provides a listing of the interface commands. A summary of all the commands is provided in TABLE 6-6. All the commands are detailed in section 6.4.1, and are presented in alphabetical order.

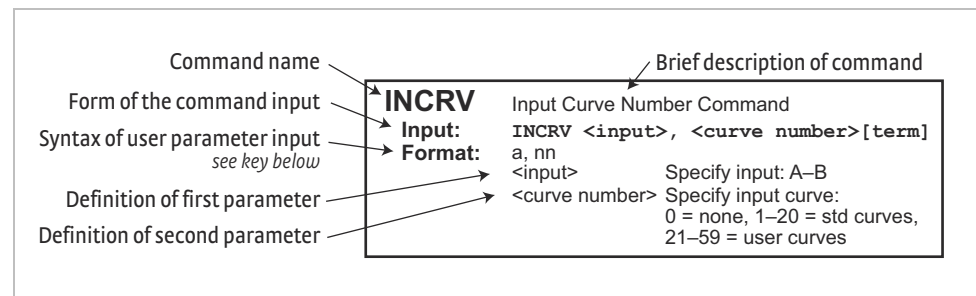

FIGURE 6-5 Sample command format

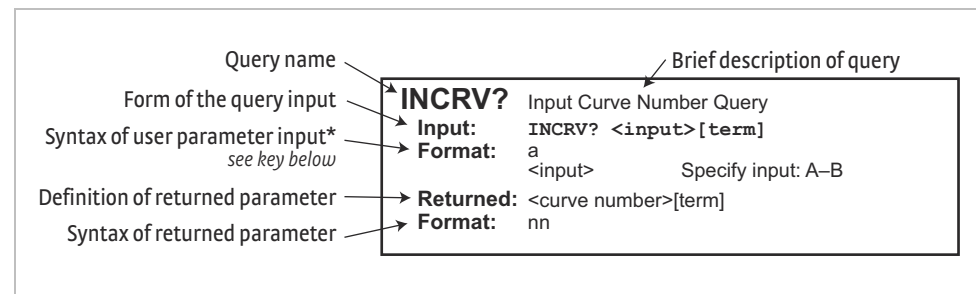

FIGURE 6-6 Sample query format

Command	Function	Page	Command	Function	Page
*CLS	Clear Interface Cmd	107	INNAME	Sensor Input Name Cmd	117
*ESE	Event Status Enable Register Cmd	107	INNAME?	Sensor Input Name Query	117
*ESE?	Event Status Enable Register Query	107	INTYPE	Input Type Parameter Cmd	118
*ESR?	Standard Event Status Register Query	108	INTYPE?	Input Type Parameter Query	118
*IDN?	Identification Query	108	KRDG?	Kelvin Reading Query	119
*OPC	Operation Complete Cmd	108	LEDS	Front Panel LEDS Cmd	119
*OPC?	Operation Complete Query	108	LEDS?	Front Panel LEDS Query	119
*RST	Reset Instrument Cmd	108	LOCK	Front Panel Keyboard Lock Cmd	119
*SRE	Service Request Enable Register Cmd	109	LOCK?	Front Panel Keyboard Lock Query	119
*SRE?	Service Request Enable Register Query	109	MDAT?	Minimum/Maximum Data Query	119
*STB?	Status Byte Query	109	MNMXRST	Minimum and Maximum Function Reset Cmd	119
*TST?	Self-Test Query	109	MODE	Remote Interface Mode Cmd	120
*WAI	Wait-to-Continue Cmd	109	MODE?	Remote Interface Mode Query	120
ALARM	Input Alarm Parameter Cmd	110	MOUT	Manual Output Cmd	120
ALARM?	Input Alarm Parameter Query	110	MOUT?	Output Manual Heater Power (MHP) Output Query	120
ALARMST?	Input Alarm Status Query	110	OPST?	Operational Status Query	120
ALMRST	Reset Alarm Status Cmd	110	OPSTE	Operation Status Enable Cmd	120
ANALOG	Monitor Out Parameter Cmd	111	OPSTE?	Operational Status Enable Query	120
ANALOG?	Monitor Out Parameter Query	111	OPSTR?	Operational Status Register Query	121
ATUNE	Autotune Cmd	111	OUTMODE	Output Mode Command	121
BRIGT	Display Brightness Cmd	111	OUTMODE?	Output Mode Query	121
BRIGT?	Display Brightness Query	112	POLARITY	Output Voltage Polarity Command	122
CRDG?	Celsius Reading Query	112	POLARITY?	Output Voltage Polarity Query	122
CRVDEL	Curve Delete Cmd	112	PID	Control Loop PID Values Cmd	121
CRVHDR	Curve Header Cmd	112	PID?	Control Loop PID Values Query	121
CRVHDR?	Curve Header Query	112	RAMP	Control Setpoint Ramp Parameter Cmd	122
CRVPT	Curve Data Point Cmd	113	RAMP?	Control Setpoint Ramp Parameter Query	122
CRVPT?	Curve Data Point Query	113	RAMPST?	Control Setpoint Ramp Status Query	122
DFLT	Factory Defaults Cmd	113	RANGE	Heater Range Cmd	123
DIOCUR	Diode Excitation Current Parameter Cmd	113	RANGE?	Heater Range Query	123
DIOCUR?	Diode Excitation Current Parameter Query	113	RDGST?	Input Reading Status Query	123
DISPFLD	Custom ModeDisplay Field Cmd	114	RELAY	Relay Control Parameter Cmd	123
DISPFLD?	Custom Mode Display Field Query	114	RELAY?	Relay Control Parameter Query	123
DISPLAY	Display Setup Cmd	114	RELAYST?	Relay Status Query	124
DISPLAY?	Display Setup Query	114	SCAL	Generate SoftCal Curve Cmd	124
EMUL	Model 331/332 Emulation Mode Cmd	115	SETP	Control Setpoint Cmd	124
EMUL?	Model 331/332 Emulation Mode Query	115	SETP?	Control Setpoint Query	124
FILTER	Input Filter Parameter Cmd	115	SRDG?	Sensor Units Input Reading Query	125
FILTER?	Input Filter Parameter Query	115	TEMP?	Thermocouple Junction Temperature Query	125
HTR?	Heater Output Query	115	TLIMIT	Temperature Limit Cmd	125
HTRSET	Heater Setup Cmd	116	TLIMIT?	Temperature Limit Query	125
HTRSET?	Heater Setup Query	116	TUNEST?	Control Tuning Status Query	125
HTRST?	Heater Status Query	116	WARMUP	Warmup Supply Parameter Cmd	126
IEEE	IEEE-488 Parameter Cmd	116	WARMUP?	Warmup Supply Parameter Query	126
IEEE?	IEEE-488 Interface Parameter Query	117	ZONE	Control Loop Zone Table Parameter Cmd	126
INCRV	Input Curve Number Cmd	117	ZONE?	Output Zone Table Parameter Query	126
INCRV?	Input Curve Number Query	117			

TABLE 6-6 Command summary

## 6.4.1 Interface Commands

This section lists the interface commands in alphabetical order.

<b>*</b>	Begins common interface command
<b>?</b>	Required to identify queries
<b>s[n]</b>	String of alphanumeric characters with length “n.” Send these strings using surrounding quotes. Quotes enable characters such as commas and spaces to be used without the instrument interpreting them as delimiters.
<b>nn...</b>	String of number characters that may include a decimal point.
<b>dd</b>	Dotted decimal format, common with IP addresses. Always contains 4 dot separated 3-digit decimal numbers, such as 192.168.000.012.
<b>[term]</b>	Terminator characters
<b>&lt;...&gt;</b>	Indicates a parameter field, many are command specific.
<b>&lt;state&gt;</b>	Parameter field with only On/Off or Enable/Disable states.
<b>&lt;value&gt;</b>	Floating point values have varying resolution depending on the type of command or query issued.

TABLE 6-7 Interface commands key

---

### \*CLS

Input

Remarks

### Clear Interface Command

\*CLS [term]

Clears the bits in the Status Byte Register, Standard Event Status Register, and Operation Event Register, and terminates all pending operations. Clears the interface, but not the controller. The related controller command is \*RST.

---

### \*ESE

Input

Format

Remarks

### Event Status Enable Register Command

\*ESE <bit weighting> [term]

nnn

Each bit is assigned a bit weighting and represents the enable/disable mask of the corresponding event flag bit in the Standard Event Status Register. To enable an event flag bit, send the command \*ESE with the sum of the bit weighting for each desired bit. Refer to section 6.2.5 for a list of event flags.

Example

To enable event flags 0, 4, and 7, send the command \*ESE 145[term]. 145 is the sum of the bit weighting for each bit.

Bit	Bit Weighting	Event Name
0	1	OPC
2	4	QXE
4	16	EXE
5	32	CME
7	128	PON
Total:	181	

---

### \*ESE?

Input

Returned

Format

### Event Status Enable Register Query

\*ESE? [term]

<bit weighting>[term]

nnn (Refer to section 6.2.5 for a list of event flags)

---

<b>*ESR?</b>	<b>Standard Event Status Register Query</b>
Input	<b>*ESR?</b> [term]
Returned	<bit weighting>
Format	nnn
Remarks	The integer returned represents the sum of the bit weighting of the event flag bits in the Standard Event Status Register. Refer to section 6.2.5 for a list of event flags.

---

<b>*IDN?</b>	<b>Identification Query</b>
Input	<b>*IDN?</b> [term]
Returned	<manufacturer>,<model>,<instrument serial>/<option serial>,<firmware version>[term]
Format	s[4],s[8],s[7]/s[7],n.n <manufacturer>      Manufacturer ID <model>                Instrument model number <instrument serial>    Instrument serial number <option card serial>    Option card serial number <firmware version>    Instrument firmware version
Example	LSCI,MODEL335,1234567/1234567,1.0

---

<b>*OPC</b>	<b>Operation Complete Command</b>
Input	<b>*OPC</b> [term]
Remarks	Generates an Operation Complete event in the Event Status Register upon completion of all pending selected device operations. Send it as the last command in a command string.

---

<b>*OPC?</b>	<b>Operation Complete Query</b>
	<b>*OPC?</b> [term]
Returned	1[term]
Remarks	Places a 1 in the controller output queue upon completion of all pending selected device operations. Send as the last command in a command string. Not the same as *OPC.

---

<b>*RST</b>	<b>Reset Instrument Command</b>
Input	<b>*RST</b> [term]
Remarks	Sets controller parameters to power-up settings.

---

**\*SRE Service Request Enable Register Command**

**Input** \*SRE <bit weighting> [term]  
**Format** nnn  
**Remarks** Each bit has a bit weighting and represents the enable/disable mask of the corresponding status flag bit in the Status Byte Register. To enable a status flag bit, send the command \*SRE with the sum of the bit weighting for each desired bit. Refer to section 6.2.6 for a list of status flags.  
**Example** To enable status flags 4, 5, and 7, send the command \*SRE 208[term]. 208 is the sum of the bit weighting for each bit.

Bit	Bit Weighting	Event Name
4	16	MAV
5	64	ESB
7	128	OSB
Total:	208	

---

**\*SRE? Service Request Enable Register Query**

**Input** \*SRE? [term]  
**Returned** <bit weighting>[term]  
**Format** nnn (Refer to section 6.2.6 for a list of status flags)

---

**\*STB? Status Byte Query**

**Input** \*STB? [term]  
**Returned** <bit weighting>[term]  
**Format** nnn  
**Remarks** Acts like a serial poll, but does not reset the register to all zeros. The integer returned represents the sum of the bit weighting of the status flag bits that are set in the Status Byte Register. Refer to section 6.2.6 for a list of status flags.

---

**\*TST? Self-Test Query**

**Input** \*TST? [term]  
**Returned** <status>[term]  
**Format** n  
 <status> 0 = no errors found, 1 = errors found  
**Remarks** The Model 335 reports status based on the test done at power up.

---

**\*WAI Wait-to-Continue Command**

**Input** \*WAI [term]  
**Remarks** Causes the IEEE-488 interface to hold off until all pending operations have been completed. This is the same function as the \*OPC command, except that it does not set the Operation Complete event bit in the Event Status Register.



---

**ALARM** Input Alarm Parameter Command

Input	<b>ALARM</b> <input>, <off/on>, <high value>, <low value>, <deadband>, <latch enable>, <audible>, <visible> [term]
Format	a,n,±nnnnnn,±nnnnnn,+nnnnnn,n,n,n <input> Specifies which input to configure: A or B. <off/on> Determines whether the instrument checks the alarm for this input, where 0 = off and 1 = on. <high setpoint> Sets the value the source is checked against to activate the high alarm. <low setpoint> Sets the value the source is checked against to activate low alarm. <deadband> Sets the value that the source must change outside of an alarm condition to deactivate an unlatched alarm. <latch enable> Specifies a latched alarm (remains active after alarm condition correction) where 0 = off (no latch) and 1 = on. <audible> Specifies if the internal speaker will beep when an alarm condition occurs. Valid entries: 0 = off, 1 = on. <visible> Specifies if the Alarm LED on the instrument front panel will blink when an alarm condition occurs. Valid entries: 0 = off, 1 = on
Remarks	Configures the alarm parameters for an input.
Example	<b>ALARM A,0</b> [term] turns off alarm checking for Input A. <b>ALARM B,1,270.0,0,0,1,1,1</b> [term] turns on alarm checking for input B, activates high alarm if kelvin reading is over 270, and latches the alarm when kelvin reading falls below 270. Alarm condition will cause instrument to beep and the front panel Alarm LED to blink.

---

**ALARM?** Input Alarm Parameter Query

Input	<b>ALARM?</b> <input> [term]
Format	a <input> A or B
Returned	<off/on>,<high value>,<low value>,<deadband>,<latch enable>,<audible>,<visible> [term]
Format	n,±nnnnnn,±nnnnnn,+nnnnnn,n,n,n (refer to command for description)

---

**ALARMST?** Input Alarm Status Query

Input	<b>ALARMST?</b> <input> [term]
Format	a <input> A - B
Returned	<high state>,<low state>[term]
Format	n,n <high state> 0 = Off, 1 = On <low state> 0 = Off, 1 = On

---

**ALMRST** Reset Alarm Status Command

Input	<b>ALMRST</b> [term]
Remarks	Clears both the high and low status of all alarms, including latching alarms.

---

<b>ANALOG</b>	<b>Monitor Out Parameter Command</b>
Input	<b>ANALOG</b> <output>, <input>, <units>, <high value>, <low value>, <polarity> [term]
Format	n,n,n,±nnnnn,±nnnnn,n <output> Output 2 is the only valid entry and must be included (included for compatibility with other Lake Shore temperature instruments). 2 = Output 2 <input> Specifies which input to monitor. 0 = none, 1 = Input A, 2 = Input B <units> Specifies the units on which to base the output voltage: 1 = kelvin, 2 = Celsius, 3 = sensor units <high value> If output mode is Monitor Out, this parameter represents the data at which the Monitor Out reaches +100% output. Entered in the units designated by the <units> parameter. Refer to OUTMODE command. <low value> If output mode is Monitor Out, this parameter represents the data at which the analog output reaches -100% output if bipolar, or 0% output if positive only. Entered in the units designated by the <units> parameter. <polarity> Specifies output voltage is 0 = unipolar (positive output only) or 1 = bipolar (positive or negative output)
Example	<b>ANALOG 2,1,1,100.0,0.0,0</b> [term] sets Output 2 Voltage mode to monitor Input A kelvin reading with 100.0 K at +100% output (+10.0 V) and 0.0 K at 0% output (0.0 V).
Remarks	Use the OUTMODE command to set the output mode to Monitor Out. The <input> parameter in the ANALOG command is the same as the <input> parameter in the OUTMODE command. It is included in the ANALOG command for backward compatibility with previous Lake Shore temperature monitors and controllers. The ANALOG command name is also named as such for backward compatibility.

---

<b>ANALOG?</b>	<b>Monitor Out Parameter Query</b>
Input	<b>ANALOG?</b> <output> [term]
Format	n
Returned	<input>, <units>, <high value>, <low value>, <polarity> [term]
Format	n,n,±nnnnn,±nnnnn,n (refer to command for definition)

---

<b>ATUNE</b>	<b>Autotune Command</b>
Input	<b>ATUNE</b> <output>, <mode>, [term]
Format	n,n <output> Specifies the output associated with the loop to be Autotuned: 1 or 2. <mode> Specifies the Autotune mode. Valid entries: 0 = P Only, 1 = P and I, 2 = P, I, and D.
Example	<b>ATUNE 2,1</b> [term] initiates Autotuning of control loop associated with output 2, in P and I mode.
Remarks	If initial conditions required to Autotune the specified loop are not met, an Autotune initialization error will occur and the Autotune process will not be performed. The TUNEST? query can be used to check if an Autotune error occurred.

---

<b>BRIGT</b>	<b>Display Brightness Command</b>
Input	<b>BRIGT</b> <brightness value> [term]
Format	n <brightness value> 0–3
Remarks	Sets the display brightness for the front panel display 0=25%, 1=50%, 2=75%, 3=100%.

<hr/>	
<b>BRIGT?</b>	<b>Display Brightness Query</b>
Input	BRIGT? [term]
Returned	<brightness value>[term]
Format	n (refer to command for description)
<hr/>	
<b>CRDG?</b>	<b>Celsius Reading Query</b>
Input	CRDG? <input> [term]
Format	a <input> A or B
Returned	<temp value>[term]
Format	±nnnnnn
Remarks	Also see the RDGST? query.
<hr/>	
<b>CRVDEL</b>	<b>Curve Delete Command</b>
Input	CRVDEL <curve> [term]
Format	nn <curve> Specifies a user curve to delete. Valid entries: 21–59.
Example	<b>CRVDEL 21[term]</b> deletes User Curve 21.
<hr/>	
<b>CRVHDR</b>	<b>Curve Header Command</b>
Input	CRVHDR <curve>, <name>, <SN>, <format>, <limit value>, <coefficient> [term]
Format	nn,s[15],s[10],n,+nnn.nnn,n <curve> Specifies which curve to configure. Valid entries: 21–59. <name> Specifies curve name. Limited to 15 characters. <SN> Specifies the curve serial number. Limited to ten characters. <format> Specifies the curve data format. Valid entries: 1 = mV/K, 2 = V/K, 3 = Ω/K, 4 = log Ω/K. <limit value> Specifies the curve temperature limit in kelvin. <coefficient> Specifies the curves temperature coefficient. Valid entries: 1 = negative, 2 = positive.
Remarks	Configures the user curve header. The coefficient parameter will be calculated automatically based on the first two curve datapoints. It is included as a parameter for compatibility with the CRVHDR? query.
Example	<b>CRVHDR 21,DT-470,00011134,2,325.0,1[term]</b> configures User Curve 21 with a name of DT-470, serial number of 00011134, data format of volts versus kelvin, upper temperature limit of 325 K, and negative coefficient.
<hr/>	
<b>CRVHDR?</b>	<b>Curve Header Query</b>
Input	CRVHDR? <curve> [term]
Format	nn <curve> Valid entries: 1–59.
Returned	<name>,<SN>,<format>,<limit value>,<coefficient>[term]
Format	s[15],s[10],n,+nnn.nnn,n (refer to command for description)

---

**CRVPT Curve Data Point Command**

<b>Input Format</b>	<b>CRVPT</b> <curve>, <index>, <units value>, <temp value> [term] nn,nnn,±nnnnnn,+nnnnnn
	<curve> Specifies which curve to configure. Valid entries: 21–59. <index> Specifies the points index in the curve. Valid entries: 1–200. <units value> Specifies sensor units for this point to six digits. <temp value> Specifies the corresponding temperature in kelvin for this point to six digits.
<b>Remarks</b>	Configures a user curve data point.
<b>Example</b>	<b>CRVPT 21,2,0.10191,470.000,N[term]</b> sets User Curve 21 second data point to 0.10191 sensor units and 470.000 K.

---

**CRVPT? Curve Data Point Query**

<b>Input Format</b>	<b>CRVPT?</b> <curve>, <index> [term] nn,nnn
	<curve> Specifies which curve to query: 1–59. <index> Specifies the points index in the curve: 1–200.
<b>Returned Format</b>	<units value>, <temp value> [term] ±nnnnnn,+nnnnnn (refer to command for description)
<b>Remarks</b>	Returns a standard or user curve data point.

---

**DFLT Factory Defaults Command**

<b>Input</b>	<b>DFLT 99</b> [term]
<b>Remarks</b>	Sets all configuration values to factory defaults and resets the instrument. The “99” is included to prevent accidentally setting the unit to defaults.

---

**DIOCUR Diode Excitation Current Parameter Command**

<b>Input Format</b>	<b>DIOCUR</b> <input>, <excitation> [term] a,n
	<input> Specifies which input to configure: A or B. <excitation > Specifies the Diode excitation current: 0 = 10 $\mu$ A, 1 = 1 mA.
<b>Remarks</b>	The 10 $\mu$ A excitation current is the only calibrated excitation current, and is used in almost all applications. Therefore the Model 335 will default the 10 $\mu$ A current setting any time the input sensor type is changed in order to prevent an accidental change. If using a current that is not 10 $\mu$ A, the input sensor type must first be configured to Diode (INTYPE command). If the sensor type is not set to Diode when the DIOCUR command is sent, the command will be ignored.

---

**DIOCUR? Diode Excitation Current Parameter Query**

<b>Input Format</b>	<b>DIOCUR?</b> <input> [term] a
	<input> A or B
<b>Returned Format</b>	<excitation> [term] n (refer to command for description)

---

### DISPFLD Custom Mode Display Field Command

Input  
Format

**DISPFLD** <field>, <source>, <units> [term]  
n,n,n

<field> Specifies field (display location) to configure: 1–4.  
<source> Specifies item to display in the field: 0 = None, 1 = Input A, 2 = Input B, 3 = Setpoint 1, 4 = Setpoint 2, 5=Output 1, 6=Output 2  
<units> Valid entries: 1 = kelvin, 2 = Celsius, 3 = sensor units, 4 = minimum data, 5 = maximum data, 6 = sensor name.

**Example** **DISPFLD 2,1,1[term]** displays kelvin reading for Input A in display field 2 when display mode is set to Custom.

**Remarks** Since each display field is only ten characters, only the first nine characters of the sensor name will be displayed when the units for a field are set to display the sensor name. However, if two adjacent fields are assigned to the same sensor name, then the entire twenty character line can be used, allowing all fifteen sensor name characters to be displayed.

This command only applies to the readings displayed in the Custom display mode. All other display modes have predefined readings in predefined locations, and will use the Preferred Units parameter to determine which units to display for each sensor input. Refer to section 4.3 for details on display setup

---

### DISPFLD? Custom Mode Display Field Query

Input  
Format

**DISPFLD?** <field> [term]  
n

<field> Specifies field (display location) to query: 1–4.

Returned  
Format

<input>,<units>[term]  
n,n (refer to command for description)

---

### DISPLAY Display Setup Command

Input  
Format

**DISPLAY** <mode> [term]  
n

<mode> Specifies display mode: 0 = Input A, 1 = Input A Max/Min, 2 = Two Input, Loop A, 3=Input B, 4=Input B Max/Min, 5=Two Input, Loop B, 6=Custom, 7=Two Loop

**Remarks** When the input display mode is set to Custom, use the DISPFLD command to configure the display.

---

### DISPLAY? Display Setup Query

Input  
Returned  
Format

**DISPLAY?** [term]  
<mode>[term]  
n (refer to command for description)

---

**EMUL Model 331/332 Interface Emulation Mode Command****Input Format** **EMUL** <emulation mode>,<PID scaling mode>[term]  
nn<emulation mode> 0=None (335), 1=331, 2=332  
<PID scaling mode> PID control scaling: 0=335 (Temperature), 1=331/332 (Sensor)**Remarks** The 331 and 332 emulation modes provide a means of using the Model 335 in place of a Model 331 or 332 in a software controlled system without updating the software. The emulation mode setting only affects remote operation; front panel operation of the Model 335 is not changed. Please reference the Model 331 or 332 user's manual for information on the interface commands for those models. For more information on using the emulation modes, see section 5.11.

---

**EMUL? Model 331/332 Interface Emulation Mode Query****Input Format** **EMUL?** [term]  
**Returned Format** <emulation mode>,<PID scaling mode>[term]  
n,n (refer to command for description)

---

**FILTER Input Filter Parameter Command****Input Format** **FILTER** <input>,<off/on>,<points>,<window> [term]  
a,n,nn,nn<input> Specifies input to configure: A or B.  
<off/on> Specifies whether the filter function is 0 = Off or 1 = On.  
<points> Specifies how many data points the filtering function uses.  
Valid range = 2–64.  
<window> Specifies what percent of full scale reading limits the filtering function.  
Reading changes greater than this percentage reset the filter. Valid range = 1 to 10%.**Example** **FILTER B,1,10,2[term]** filter input B data through ten readings with 2% of full scale window.

---

**FILTER? Input Filter Parameter Query****Input Format** **FILTER?** <input> [term]  
a  
**Returned Format** <input> Specifies input to query: A or B.  
<off/on>,<points>,<window>[term]  
n,nn,nn (refer to command for description)

---

**HTR? Heater Output Query****Input Format** **HTR?** <output> [term]  
n  
**Returned Format** <output> Heater output to query: 1 = Output 1, 2 = Output 2  
<heater value>[term]  
±nnn.n  
<heater value>

Percent of full scale current for Output 1 and Output 2 in Current mode, or percent of full scale voltage for Output 2 in Voltage mode.

<hr/>	
<b>HTRSET</b>	<b>Heater Setup Command</b>
Input	<b>HTRSET</b> <output>, <type>, <heater resistance>, <max current>, <max user current>, <current/power> [term]
Format	n,n,n,n,+n.nnn,n <output> Specifies which heater output to configure: 1 or 2. <type> Output type (Output 2 only): 0=Current, 1=Voltage <htr resistance> Heater Resistance Setting: 1 = 25 $\Omega$ , 2 = 50 $\Omega$ . <max current> Specifies the maximum heater output current: 0 = User Specified, 1 = 0.707 A, 2 = 1 A, 3 = 1.141 A, 4 = 1.732 A <max user current> Specifies the maximum heater output current if max current is set to User Specified. <current/power> Specifies whether the heater output displays in current or power (current mode only). Valid entries: 1 = current, 2 = power.
Example	<b>HTRSET 2,0,1,2,0,1</b> [term] Heater Output 2 uses the current source output, the 25 $\Omega$ heater setting, has a maximum current of 1 A, the maximum user current is set to 0 A because it is not going to be used since a discrete value has been chosen, and the heater output will be displayed in units of current.
Remarks	Max current will be limited to 1 A on Output 1 if the heater resistance is set to 50 $\Omega$ . If the heater resistance is set to 25 $\Omega$ on Output 1, then the max current will be limited to 1.414 A if Output 2 is in Current mode, or 1.732 A if Output 2 is in Voltage mode. See section 4.5.1.3 for more information on the max current setting.
<hr/>	
<b>HTRSET?</b>	<b>Heater Setup Query</b>
Input	<b>HTRSET?</b> <output> [term]
Format	n <output> Specifies which heater output to query: 1 or 2.
Returned Format	<type>,<htr resistance>,<max current>,<max user current>,<current/power>[term] n,n,n,+n.nnn,n
<hr/>	
<b>HTRST?</b>	<b>Heater Status Query</b>
Input	<b>HTRST?</b> <output> [term]
Format	n <output> Specifies which heater output to query: 1 or 2.
Returned Format	<error code>[term] n
Remarks	<error code> Heater error code: 0 = no error, 1 = heater open load, 2 = heater short. Error condition is cleared upon querying the heater status, which will also clear the front panel error message
<hr/>	
<b>IEEE</b>	<b>IEEE-488 Interface Parameter Command</b>
Input	<b>IEEE</b> <address> [term]
Format	nn <address> Specifies the IEEE address: 1–30. (Address 0 and 31 are reserved.)
Example	<b>IEEE 4</b> [term] after receipt of the current terminator, the instrument responds to address 4.

<b>IEEE?</b>	<b>IEEE-488 Interface Parameter Query</b>
Input	IEEE? [term]
Returned	<address>[term]
Format	nn (refer to command for description)
<hr/>	
<b>INCRV</b>	<b>Input Curve Number Command</b>
Input	INCRV <input>,<curve number> [term]
Format	a,nn
	<input> Specifies which input to configure: A or B.
	<curve number> Specifies which curve the input uses. If specified curve type does not match the configured input type, the curve number defaults to 0. Valid entries: 0 = none, 1–20 = standard curves, 21–59 = user curves.
Remarks	Specifies the curve an input uses for temperature conversion.
Example	<b>INCRV A,23[term]</b> Input A uses User Curve 23 for temperature conversion.
<hr/>	
<b>INCRV?</b>	<b>Input Curve Number Query</b>
Input	INCRV? <input> [term]
Format	a
	<input> Specifies which input to query: A or B.
Returned	<curve number>[term]
Format	nn (refer to command for description)
<hr/>	
<b>INNAME</b>	<b>Sensor Input Name Command</b>
Input	INNAME <input>,<name> [term]
Format	a,s[15]
	<input> Specifies input to configure: A or B.
	<name> Specifies the name to associate with the sensor input.
Example	<b>INNAME A, "Sample Space"[term]</b> the string "Sample Space" will appear on the front panel display when possible to identify the sensor information being displayed.
Remarks	Be sure to use quotes when sending strings, otherwise characters such as spaces, and other non alpha-numeric characters, will be interpreted as a delimiter and the full string will not be accepted. It is not recommended to use commas or semi-colons in sensor input names as these characters are used as delimiters for query responses.
<hr/>	
<b>INNAME?</b>	<b>Sensor Input Name Query</b>
Input	INNAME? <input> [term]
Format	a
	<input> Specifies input to query: A or B.
Returned	<name>[term]
Format	s[15] (refer to command for description)



**INTYPE** Input Type Parameter Command

**Input** INTYPE <input>,<sensor type>,<autorange>,<range>,<compensation>,<units> [term]

**Format** a,n,n,n,n,n

<input> Specifies input to configure: A or B  
 <sensor type> Specifies input sensor type:  
 0 = Disabled  
 1 = Diode  
 2 = Platinum RTD  
 3 = NTC RTD  
 4 = Thermocouple  
 <autorange> Specifies autoranging: 0 = off and 1 = on.  
 <range> Specifies input range when autorange is off:

Diode	0 = 2.5 V
	1 = 10 V
PTC RTD	0 = 10 $\Omega$
	1 = 30 $\Omega$
	2 = 100 $\Omega$
	3 = 300 $\Omega$
	4 = 1 k $\Omega$
	5 = 3 k $\Omega$
NTC RTD	6 = 10 k $\Omega$
	0 = 10 $\Omega$
	1 = 30 $\Omega$
	2 = 100 $\Omega$
	3 = 300 $\Omega$
	4 = 1 k $\Omega$
	5 = 3 k $\Omega$
	6 = 10 k $\Omega$
7 = 30 k $\Omega$	
8 = 100 k $\Omega$	
Thermocouple	0 = 50 mV

TABLE 6-8 *Input range*

<compensation> Specifies input compensation where 0 = off and 1 = on. Reversal for thermal EMF compensation if input is resistive, room compensation if input is thermocouple. Always 0 if input is a diode.

<units> Specifies the preferred units parameter for sensor readings and for the control setpoint: 1 = kelvin, 2 = Celsius, 3 = Sensor

**Example** INTYPE A,2,1,0,1,1[term] sets Input A sensor type to Platinum RTD, autorange on, thermal compensation on, and preferred units to kelvin.

**Remarks** The <autorange> and <range> parameters do not apply to thermocouple sensor type, and the <autorange> and <compensation> parameters do not apply to diode sensor type. When configuring diode or thermocouple sensor types, these parameters must be included, but are ignored. A setting of 0 for each is recommended in this case.

**INTYPE?** Input Type Parameter Query

**Input** INTYPE? <input> [term]

**Format** a

<input> Specifies input to query: A or B.

**Returned** <sensor type>,<autorange>,<range>,<compensation>,<units> [term]

**Format** n,n,n,n,n (refer to command for description)

**Remarks** If autorange is on, the returned range parameter is the currently auto-selected range.



<b>MODE</b>	<b>Remote Interface Mode Command</b>
Input	MODE <mode> [term]
Format	n <mode>                            0 = local, 1 = remote, 2 = remote with local lockout.
Example	<b>MODE 2[term]</b> places the Model 335 into remote mode with local lockout.
<b>MODE?</b>	<b>Remote Interface Mode Query</b>
Input	MODE? [term]
Returned	<mode>[term]
Format	n (refer to command for description)
<b>MOUT</b>	<b>Manual Output Command</b>
Input	MOUT <output>, <value> [term]
Format	n, +nnnnn[term] <output>                            Specifies output to configure: 1 or 2. <value>                              Specifies value for manual output.
Example	<b>MOUT 1,22.45[term]</b> Output 1 manual output is 22.45%.
Remarks	Manual output only applies to outputs in Closed Loop PID, Zone, or Open Loop modes.
<b>MOUT?</b>	<b>Manual Output Query</b>
Input	MOUT? <output> [term]
Format	n <output>                            Specifies which output to query: 1 or 2.
Returned	<value>
Format	+ nnnnn[term] (refer to command for description)
<b>OPST?</b>	<b>Operational Status Query</b>
Input	OPST? [term]
Returned	<bit weighting> [term]
Format	nnn
Remarks	The integer returned represents the sum of the bit weighting of the operational status bits. Refer to section 6.2.5.2 for a list of operational status bits.
<b>OPSTE</b>	<b>Operational Status Enable Command</b>
Input	OPSTE <bit weighting> [term]
Format	nnn
Remarks	Each bit has a bit weighting and represents the enable/disable mask of the corresponding operational status bit in the Operational Status Register. This determines which status bits can set the corresponding summary bit in the Status Byte Register. To enable a status bit, send the command OPSTE with the sum of the bit weighting for each desired bit. Refer to section 6.2.5.2 for a list of operational status bits.
<b>OPSTE?</b>	<b>Operational Status Enable Query</b>
Input	OPSTE? [term]
Returned	<bit weighting> [term]
Format	nnn (Refer to section 6.2.5.2 for a list of operational status bits)

---

**OPSTR? Operational Status Register Query**

Input	OPSTR? [term]
Returned	<bit weighting> [term]
Format	nnn
Remarks	The integers returned represent the sum of the bit weighting of the operational status bits. These status bits are latched when the condition is detected. This register is cleared when it is read. Refer to section 6.2.5.2 for a list of operational status bits.

---

**OUTMODE Output Mode Command**

Input	OUTMODE <output>, <mode>, <input>, <powerup enable> [term]
Format	n,n,n,n
	<output> Specifies which output to configure: 1 or 2.
	<mode> Specifies the control mode. Valid entries: 0 = Off, 1 = Closed Loop PID, 2 = Zone, 3 = Open Loop, 4 = Monitor out, 5 = Warmup Supply
	<input> Specifies which input to use for control: 0 = None, 1 = A, 2 = B
	<powerup enable> Specifies whether the output remains on or shuts off after power cycle. Valid entries: 0 = powerup enable off, 1 = powerup enable on.

Example	<b>OUTMODE 1,2,1,0[term]</b> Output 1 configured for Zone control mode, using Input A for the control input sensor, and will turn the output off when power is cycled.
Remarks	Modes 4 and 5 are only valid for Output 2 in Voltage mode.

---

**OUTMODE? Output Mode Query**

Input	OUTMODE? <output> [term]
Format	n
	<output> Specifies which output to query: 1 or 2.
Returned	<mode>, <input>, <powerup enable> [term]
Format	n,n,n (refer to command for description)

---

**PID Control Loop PID Values Command**

Input	PID <output>, <P value>, <I value>, <D value> [term]
Format	n,+nnnnn,+nnnnn,+nnnn
	<output> Specifies which output's control loop to configure: 1 or 2.
	<P value> The value for output Proportional (gain): 0.1 to 1000.
	<I value> The value for output Integral (reset): 0.1 to 1000.
	<D value> The value for output Derivative (rate): 0 to 200.
Remarks	Control settings, (P, I, D, and Setpoint) are assigned to outputs, which results in the settings being applied to any loop formed by the output and its control input.
Example	<b>PID 1,10,50,0[term]</b> Output 1 P is 10, I is 50, and D is 0%.

---

**PID? Control Loop PID Values Query**

Input	PID? <output> [term]
Format	n
	<output> Specifies which output's control loop to query: 1 or 2.
Returned	<P value>, <I value>, <D value> [term]
Format	+nnnnn,+nnnnn,+nnnn (refer to command for description)

<hr/>	
<b>POLARITY</b>	<b>Output Voltage Polarity Command</b>
Input	<b>POLARITY</b> <output>, <polarity> [term]
Format	n,n <output>                      Output for which to configure the polarity setting: 2 <polarity>                      Specifies output voltage is 0=unipolar (positive output only) or 1=bipolar (positive or negative output)
Remarks	The polarity command only applies to Output 2, and only when output type is voltage.
<hr/>	
<b>POLARITY?</b>	<b>Output Voltage Polarity Query</b>
Input	<b>POLARITY?</b> [term]
Returned	<polarity>[term]
Format	n (refer to command for description)
<hr/>	
<b>RAMP</b>	<b>Control Setpoint Ramp Parameter Command</b>
Input	<b>RAMP</b> <output>, <off/on>, <rate value> [term]
Format	n,n,nnnn <output>                      Specifies which output's control loop to configure: 1 or 2. <off/on>                      Specifies whether ramping is 0 = Off or 1 = On. <rate value>                      Specifies setpoint ramp rate in kelvin per minute from 0.1 to 100. The rate is always positive, but will respond to ramps up or down. A rate of 0 is interpreted as infinite, and will therefore respond as if setpoint ramping were off.
Example	<b>RAMP 1,1,10.5</b> [term] when Output 1 setpoint is changed, ramp the current setpoint to the target setpoint at 10.5 K/minute.
Remarks	Control loop settings are assigned to outputs, which results in the settings being applied to the control loop formed by the output and its control input.
<hr/>	
<b>RAMP?</b>	<b>Control Setpoint Ramp Parameter Query</b>
Input	<b>RAMP?</b> <output> [term]
Format	n <output>                      Specifies which output's control loop to query: 1 or 2.
Returned	<off/on>,<rate value>[term]
Format	n,nnnn (refer to command for description)
<hr/>	
<b>RAMPST?</b>	<b>Control Setpoint Ramp Status Query</b>
Input	<b>RAMPST?</b> <output> [term]
Format	n <output>                      Specifies which output's control loop to query: 1 or 2.
Returned	<ramp status>[term]
Format	n <ramp status>                      0 = Not ramping, 1 = Setpoint is ramping.

**RANGE Heater Range Command**

<b>Input</b>	<b>RANGE</b> <output>, <range> [term]
<b>Format</b>	n,n <output> Specifies which output to configure: 1 or 2. <range> For Outputs 1 and 2 in Current mode: 0 = Off, 1 = Low, 2 = Medium, 3 = High For Output 2 in Voltage mode: 0 = Off, 1 = On
<b>Remarks</b>	The range setting has no effect if an output is in the Off mode, and does not apply to an output in Monitor Out mode. An output in Monitor Out mode is always on.

**RANGE? Heater Range Query**

<b>Input</b>	<b>RANGE?</b> <output> [term]
<b>Format</b>	n <output> Specifies which output to query: 1 or 2.
<b>Returned</b>	<range>[term]
<b>Format</b>	n (refer to command for description)

**RDGST? Input Reading Status Query**

<b>Input</b>	<b>RDGST?</b> <input> [term]
<b>Format</b>	a <input> Specifies which input to query: A or B.
<b>Returned</b>	<status bit weighting>[term]
<b>Format</b>	nnn
<b>Remarks</b>	The integer returned represents the sum of the bit weighting of the input status flag bits. A "000" response indicates a valid reading is present..

Bit	Bit Weighting	Status Indicator
0	1	invalid reading
4	16	temp underrange
5	32	temp overrange
6	64	sensor units zero
7	128	sensor units overrange

**RELAY Relay Control Parameter Command**

<b>Input</b>	<b>RELAY</b> <relay number>, <mode>, <input alarm>, <alarm type> [term]
<b>Format</b>	n,n,a,n <relay number> Specifies which relay to configure: 1 or 2. <mode> Specifies relay mode. 0 = Off, 1 = On, 2 = Alarms. <input alarm> Specifies which input alarm activates the relay when the relay is in alarm mode: A or B. <alarm type> Specifies the input alarm type that activates the relay when the relay is in alarm mode. 0 = Low alarm, 1 = High Alarm, 2 = Both Alarms.

**Example** **RELAY 1,2,B,0**[term] relay 1 activates when Input B low alarm activates.

**RELAY? Relay Control Parameter Query**

<b>Input</b>	<b>RELAY?</b> <relay number> [term]
<b>Format</b>	n <relay number> Specifies which relay to query: 1 or 2.
<b>Returned</b>	<mode>, <input alarm>, <alarm type> [term]
<b>Format</b>	n,a,n (refer to command for description)

<hr/>	
<b>RELAYST?</b>	<b>Relay Status Query</b>
Input	RELAYST? <relay number> [term]
Format	n <relay number>                      Specifies which relay to query: 1 or 2.
Returned	<status>[term]
Format	n    0 = Off, 1 = On.
<hr/>	
<b>SCAL</b>	<b>Generate SoftCal Curve Command</b>
Input	SCAL <std>, <dest>, <SN>, <T1 value>, <U1 value>, <T2 value>, <U2 value>, <T3 value>, <U3 value> [term]
Format	n, nn, S[10], +nnnnnn, ±nnnnnn, +nnnnnn, ±nnnnnn, +nnnnnn, ±nnnnnn <std>                                      Specifies the standard curve from which to generate a SoftCal™ curve. Valid entries: 1, 6, 7. <dest>                                      Specifies the user curve to store the SoftCal™ curve. Valid entries: 21–59. <SN>                                        Specifies the curve serial number. Limited to ten characters. <T1 value>                                Specifies first temperature point in kelvin. <U1 value>                                Specifies first sensor units point. <T2 value>                                Specifies second temperature point in kelvin. <U2 value>                                Specifies second sensor units point. <T3 value>                                Specifies third temperature point in kelvin. <U3 value>                                Specifies third sensor units point.
Remarks	Generates a SoftCal™ curve. Refer to Paragraph 5.3.
Example	<b>SCAL 1,21,1234567890,4.2,1.6260,77.32,1.0205,300.0,0.5189[term]</b> generates a three-point SoftCal™ curve from standard curve 1 and saves it in user curve 21.
<hr/>	
<b>SETP</b>	<b>Control Setpoint Command</b>
Input	SETP <output>, <value> [term]
Format	n, ±nnnnnn <output>                                    Specifies which output's control loop to configure: 1 or 2. <value>                                     The value for the setpoint (in the preferred units of the control loop sensor).
Example	<b>SETP 1,122.5[term]</b> Output 1 setpoint is now 122.5 (based on its units).
Remarks	Control settings, that is, P, I, D, and Setpoint, are assigned to outputs, which results in the settings being applied to the control loop formed by the output and its control input.
<hr/>	
<b>SETP?</b>	<b>Control Setpoint Query</b>
Input	SETP? <output> [term]
Format	n <output>                                    Specifies which output to query: 1 or 2.
Returned	<value>[term]
Format	±nnnnnn (refer to command for description)

<b>SRDG?</b>	<b>Sensor Units Input Reading Query</b>
Input	SRDG? <input> [term]
Format	a <input> Specifies which input to query: A or B.
Returned	<sensor units value>[term]
Format	±nnnnnn
Remarks	Also see the RDGST? command.
<b>TEMP?</b>	<b>Thermocouple Junction Temperature Query</b>
Input	TEMP? [term]
Returned	<junction temperature>[term]
Format	+nnnnn
Remarks	Temperature is in kelvin. This query returns the temperature of the ceramic thermocouple block used in the room temperature compensation calculation
<b>TLIMIT</b>	<b>Temperature Limit Command</b>
Input	TLIMIT <input>, <limit> [term]
Format	n+nnnn <input> Specifies which input to configure: A or B. <limit> The temperature limit in kelvin for which to shut down all control outputs when exceeded. A temperature limit of zero turns the temperature limit feature off for the given sensor input.
Example	<b>TLIMIT B,450[term]</b> if the temperature of the sensor on Input B exceeds 450 K, all control outputs will be turned off.
Remarks	A temperature limit setting of 0 K turns the temperature limit feature off.
<b>TLIMIT?</b>	<b>Temperature Limit Query</b>
Input	TLIMIT? <input> [term]
Format	a <input> Specifies which input to query: A or B.
Returned	< limit>[term]
Format	+nnnn (refer to command for description)
<b>TUNEST?</b>	<b>Control Tuning Status Query</b>
Input	TUNEST? [term]
Returned	<tuning status>,<output>,<error status>,<stage status>[term]
Format	n,n,n,nn <tuning status> 0 = no active tuning, 1 = active tuning. <output> Heater output of the control loop being tuned (if tuning): 1 = Output 1, 2 = Output 2 <error status> 0 = no tuning error, 1 = tuning error <stage status> Specifies the current stage in the Autotune process. If tuning error occurred, stage status represents stage that failed.
Remarks	If initial conditions are not met when starting the autotune procedure, causing the autotuning process to never actually begin, then the error status will be set to 1 and the stage status will be stage 00.





# Chapter 7: Options and Accessories

## 7.1 General

This chapter provides information on the models, options, and accessories available for the Model 335 temperature controller.

## 7.2 Models

The list of Model 335 model numbers is provided as follows:

Model	Description of Models
335	Standard temperature controller. two diode/RTD inputs and two control outputs

TABLE 7-1 Model description

Power configurations: the instrument is configured at the factory for customer-selected power as follows:

VAC-100	Instrument configured for 100 VAC with U.S. power cord
VAC-120	Instrument configured for 120 VAC with U.S. power cord
VAC-220	Instrument configured for 220 VAC with universal Euro line cord
VAC-240	Instrument configured for 240 VAC with universal Euroline cord
VAC-120-ALL	Instrument configured for 120 VAC with U.S. power cord and universal Euro line cord and fuses for 220/240 VAC setting

Other country line cords available, consult Lake Shore

TABLE 7-2 Power configurations

## 7.3 Options

The list of Model 335 options is provided as follows:

Model	Description of Options
3060-H	2-thermocouple input option card. Adds two thermocouple inputs to the Model 335.

TABLE 7-3 Model description

## 7.4 Accessories

Accessories are devices that perform a secondary duty as an aid or refinement to the primary unit. Refer to the Lake Shore Temperature Measurement and Control Catalog for details. A list of accessories available for the Model 335 is as follows:

Model	Description of Accessories
106-009*†	Heater output connector (dual banana jack)
G-106-233*†	Sensor input mating connector. (6-pin DIN plug); two included
G-106-735*†	Terminal block, 8-pin
MAN-335*†	Model 335 user manual.
112-177†	Sensor/heater cable assembly: 10 Feet. Cable assembly for two diode/resistor sensors and 2 heater outputs. Approximately 3 m (10 ft) long. Refer to FIGURE 7-1.
112-178†	Sensor/heater cable assembly: 20 Feet. Cable assembly for two diode/resistor sensors and two heater outputs. Approximately 6 m (20 ft) long. Refer to FIGURE 7-1.
3003	Heater output conditioner. The heater output conditioner is a passive filter that further reduces the already low heater output noise of the Model 335. Refer to section 7.7 and see FIGURE 7-3.
6201†	1 m (3.3 ft) long IEEE-488 computer interface cable assembly
8001-335	CalCurve™, factory installed: the breakpoint table from a calibrated sensor stored in the instrument
CAL-335-CERT†	Instrument recalibration with certificate
CAL-335-DATA†	Instrument recalibration with certificate and data

TABLE 7-4 Accessories

Model	Description of Accessories
ES-2-20	Stycast® epoxy 2850-FT, Catalyst 9 (20 packets, 2 g each). Stycast® is a common, highly versatile, nonconductive epoxy resin system for cryogenic use. The primary use for Stycast® is for vacuum feedthroughs or permanent thermal anchors. Stycast® is an alternative to Apiezon® N Grease when permanent sensor mountings are desired.
ID-10-XX	Indium solder disks (Quantity 10). Indium is a semi-precious non-ferrous metal, softer than lead, and extremely malleable and ductile. It stays soft and workable down to cryogenic temperatures. Indium can be used to create solder "bumps" for microelectronic chip attachments and also as gaskets for pressure and vacuum sealing purposes. ID-10-31 Indium Disks are 7.92 mm diameter × 0.13 mm (0.312 in diameter × 0.005 in) ID-10-56 Indium Disks are 14.27 mm diameter × 0.127 mm (0.562 diameter × 0.005 in)
IF-5	Indium foil sheets (Quantity 5). When used as a washer between DT-470-CU silicon diode or other temperature sensors and refrigerator cold stages, indium foil increases the thermal contact area and prevents the sensor from detaching due to vibration. It also may be used as a sealing gasket for covers, flanges, and windows in cryogenic applications. Each sheet is 0.13 mm × 50.8 mm × 50.8 mm (0.005 in × 2 in × 2 in).
GAH-25	Apiezon® H grease, 25 g tube. It is designed for general purposes where operating temperatures necessitate the use of a relatively high melting point grease. Melting point is 523 K (250 °C). Can be removed using Xylene with an isopropyl alcohol rinse.
GAN-25	Apiezon® N grease, 25 g tube. General purpose grease well-suited for cryogenic use because of its low viscosity. It is often used as a means of thermally anchoring cryogenic sensors as well as lubricating joints and o-rings. Contains high molecular weight polymeric hydrocarbon additive that gives it a tenacious, rubbery consistency allowing the grease to form a cushion between mating surfaces. Melting point is 316 K (43 °C). Can be removed using Xylene with an isopropyl alcohol rinse.
HTR-25	25 Ω cartridge heater. The heater features precision-wound nickel-chromium resistance wire, magnesium oxide insulation, two solid pins, non-magnetic package, and has UL and CSA component recognition. The heater is 25 Ω, 6.35 mm (0.25 in) diameter by 25.4 mm (1 in) long. The 25 Ω rating is in dead air. With proper heat sinking, the cartridge heater can handle many times this dead air power rating.
HTR-50	50 Ω cartridge heater. The heater features precision-wound nickel-chromium resistance wire, magnesium oxide insulation, two solid pins, non-magnetic package, and has UL and CSA component recognition. The heater is 50 Ω, 6.35 mm (0.25 in) diameter by 25.4 mm (1 in) long. The 50 Ω rating is in dead air. With proper heat sinking, the cartridge heater can handle many times this dead air power rating.
RM-1/2	Half-rack mounting kit for one Model 335 temperature controller. Half-length mounting panel and mounting ears to attach one Model 335 to a 483 mm (19 in) rack mount space. See FIGURE 7-2.
RM-2	Dual mounting shelf for two Model 335 temperature controllers. Mounting shelf to attach any two 5.25 in tall half-rack instruments side-by-side on a 483 mm (19 in) rack mount shelf.
VGE-7031	IMI-7031 varnish (formerly GE 7031 Varnish) (1 pint can). IMI-7031 insulating varnish and adhesive possesses electrical and bonding properties which, when combined with its chemical resistance and good saturating properties, make it an excellent material for cryogenic temperatures. As an adhesive, IMI-7031 bonds a variety of materials, has fast tack time, and may be air dried or baked. It is also an electrically insulating adhesive at cryogenic temperatures and is often used as a calorimeter cement. When soaked into cigarette paper, it makes a good, high thermal conductivity, low electrical conductivity heat sinking layer. Maximum operating temperature: 423 K (150 °C).
Wire	Lake Shore cryogenic wire. Lake Shore sells the following types of cryogenic wire: DT = Duo-Twist, MN = Single Strand, MW = Manganin, NC = Nichrome Heater, ND = Heavy Duty, QL = Quad-Lead, and QT = Quad-Twist. Lake Shore Coaxial Cable. Lake Shore sells the following types of coaxial cable: CC = Ultra Miniature Coaxial Cable, SR = Semi-Rigid Coaxial Cable, CRYC = CryoCable.

\*Accessories included with a new Model 335

†RoHS compliant

TABLE 7-4 Accessories

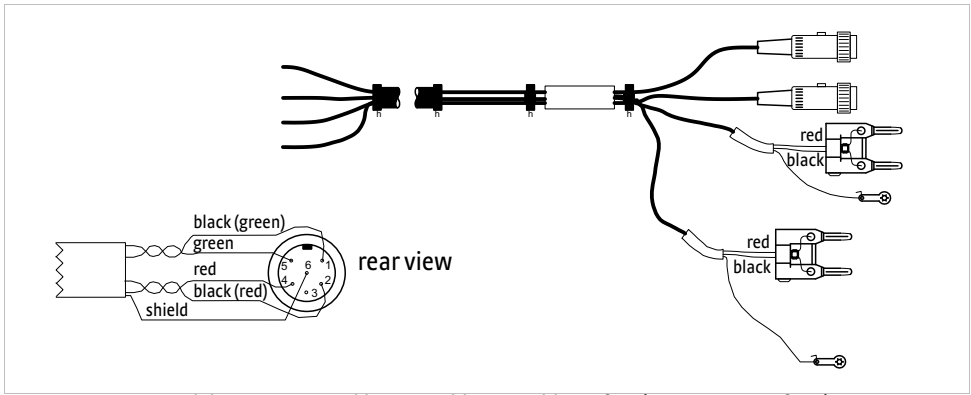

FIGURE 7-1 Model 335 sensor and heater cable assembly 10 ft: P/N 112-177, 20 ft: P/N 112-178

### 7.5 Rack Mounting

The Model 335 can be installed into a 483 mm (19 in) rack mount cabinet using the optional Lake Shore Model RM-1/2 rack mount kit. The rack mount kit contains mounting ears, panel, handles, and screws that adapt the front panel to fit into a 88.9 mm (3.5 in) tall full rack space. Refer to FIGURE 7-2 for installation details.

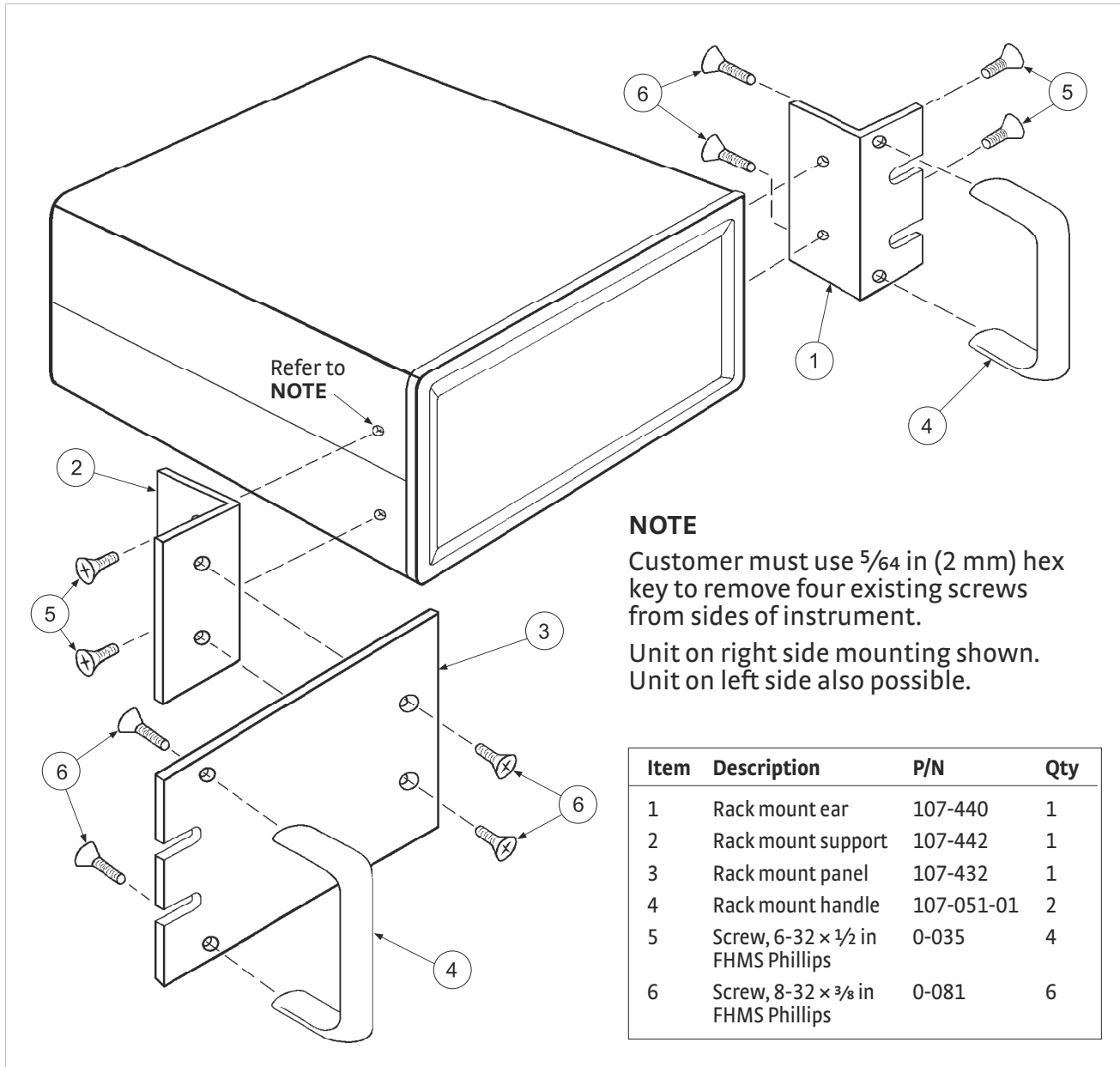

**Ensure that there is a 25 mm (1 in) clearance on both sides of the instrument after rack mounting.**

FIGURE 7-2 Model RM- $\frac{1}{2}$  rack mount kit

## 7.6 Model 3060-H Thermocouple Input Option

The field installable Model 3060-H thermocouple input option adds thermocouple functionality to inputs A and B. While the option can be easily removed, this is not necessary as the standard inputs remain fully functional when they are not being used to measure thermocouple temperature sensors. Calibration for the option is stored on the card so it can be installed in the field and used with multiple Model 335 temperature controllers without recalibration.

## 7.7 Model 3003 Heater and Output Conditioner

The Lake Shore Model 3003 heater output conditioner is a passive filter that reduces the already low noise present in the heater output of the Model 335. The Model 3003 connects between the heater output terminals on the rear panel of a controller and a resistive heater. See FIGURE 7-3.

Specifications are as follows:

- Max Current: 2 A
- Max Voltage: 60 V
- Attenuation: 50 or 60 Hz (line frequency): 20 dB
- 100 Hz and above (line frequency harmonics): 40 dB
- Enclosure Size: 144 mm wide × 72 mm long × 165 mm deep (5.7 × 2.8 × 6.5 in)
- Weight: 1.6 kg (3.5 lb)

The Model 3003 is a passive filter and requires no external power supply. The High and Low terminals on the controller must be connected to the High and Low terminals marked From Controller on the Model 3003. The binding posts or a dual banana plug can be used to connect to the Model 3003. Precautions must be taken to ensure the High and Low terminals are not reversed. A diode in the Model 3003 shorts the heater output if the polarity of the terminals is reversed.

The High and Low terminals marked To Heater on the Model 3003 should be attached to a resistive heater used for temperature control. The binding posts or a dual banana plug can be used to connect to the Model 3003. The ground terminals on the Model 3003 continue the shield if the heater cable is shielded.

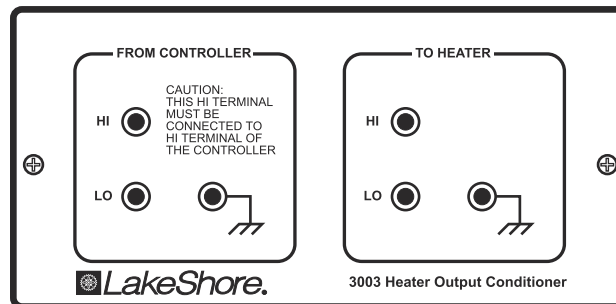

FIGURE 7-3 Model 3003 heater output conditioner



# Chapter 8: Service

## 8.1 General

This chapter provides basic service information for the Model 335 temperature controller. Customer service of the product is limited to the information presented in this chapter. Factory trained service personnel should be consulted if the instrument requires repair.

## 8.2 USB Troubleshooting

This section provides USB interface troubleshooting for issues that arise with new installations, existing installations, and intermittent lockups.

### 8.2.1 New Installation

1. Check that the USB driver is installed properly and that the device is functioning. In Microsoft Windows®, the device status can be checked using Device Manager by right-clicking **Lake Shore Model 335 Temperature Controller** under **Ports (COM & LPT)** or **Other Devices** and then clicking **Properties**. Refer to section 6.3.3 for details on installing the USB driver.
2. Check that the correct com port is being used. In Microsoft Windows®, the com port number can be checked using Device Manager under **Ports (COM & LPT)**.
3. Check that the correct settings are being used for communication. Refer to section 6.3.3 for details on installing the USB driver.
4. Check cable connections and length.
5. Send the message terminator.
6. Send entire message string at one time including the terminator. (Many terminal emulation programs do not.)
7. Send only one simple command at a time until communication is established.
8. Be sure to spell commands correctly and use proper syntax.

### 8.2.2 Existing Installation No Longer Working

1. Power the instrument off, then on again to see if it is a soft failure.
2. Power the computer off, then on again to see if communication port is locked up.
3. Check all the cable connections.
4. Check that the com port assignment has not been changed. In Microsoft Windows®, the com port number can be checked using Device Manager under **Ports (COM & LPT)**.
5. Check that the USB driver is installed properly and that the device is functioning. In Microsoft Windows®, the device status can be checked using Device Manager by right-clicking **Lake Shore Model 335 Temperature Controller** under **Ports (COM & LPT)** or **Other Devices** and then clicking **Properties**.

### 8.2.3 Intermittent Lockups

1. Check cable connections and length.
2. Increase delay between all commands to 100 ms to make sure the instrument is not being overloaded.
3. Ensure that the USB cable is not unplugged and that the Model 335 is not powered down while the com port is open. The USB driver creates a com port when the USB connection is detected, and removes the com port when the USB connection is no longer detected. Removal of the com port while it is in use by the software can cause the software to lock up or crash.



## 8.3 IEEE Interface Troubleshooting

### 8.3.1 New Installation

This section provides IEEE interface troubleshooting for issues that arise with new installations, old installations, and intermittent lockups.

1. Check the instrument address.
2. Always send a message terminator.
3. Send the entire message string at one time including the terminator.
4. Send only one simple command at a time until communication is established.
5. Be sure to spell commands correctly and use proper syntax.
6. Attempt both Talk and Listen functions. If one works but not the other, the hardware connection is working, so look at syntax, terminator, and command format.

### 8.3.2 Existing Installation No Longer Working

1. Power the instrument off and then on again to see if it is a soft failure.
2. Power the computer off and then on again to see if the IEEE card is locked up.
3. Verify that the address has not been changed on the instrument during a memory reset.
4. Check all cable connections.

### 8.3.3 Intermittent Lockups

1. Check cable connections and length.
2. Increase the delay between all commands to 50 ms to make sure the instrument is not being overloaded.

## 8.4 Fuse Drawer

The fuse drawer supplied with the Model 335 holds the instrument line fuses and line voltage selection module. The drawer holds two 5 mm × 20 mm (0.2 in × .79 in) time delay fuses. It requires two good fuses of the same rating to operate safely. Refer to Section 8.5 for details.

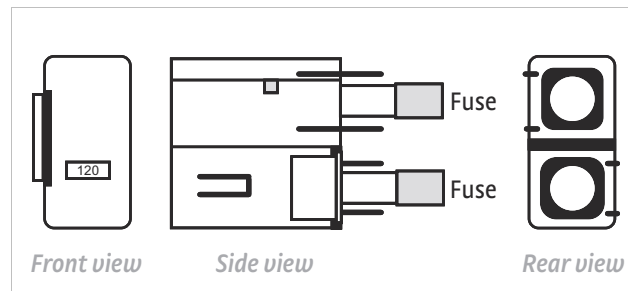

FIGURE 8-1 Fuse drawer

## 8.5 Line Voltage Selection

Use the following procedure to change the instrument line voltage selector.



**To avoid potentially lethal shocks, turn off the controller and disconnect it from AC power before performing these procedures.**

1. Identify the line input assembly on the instrument rear panel. See FIGURE 8-2.
2. Turn the line power switch off (O).
3. Remove the instrument power cord.
4. With a small screwdriver, release the drawer holding the line voltage selector and fuse.
5. Slide out the removable plastic fuse holder from the drawer.
6. Rotate the fuse holder until the proper voltage indicator shows through the window.
7. Re-assemble the line input assembly in the reverse order.
8. Verify the voltage indicator in the window of the line input assembly.
9. Connect the instrument power cord.
10. Turn the line power switch on (I). Refer to FIGURE 8-2.

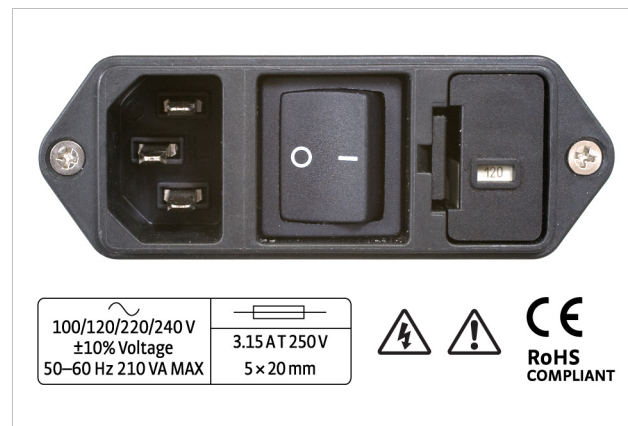

FIGURE 8-2 Power fuse access

## 8.6 Fuse Replacement

Use this procedure to remove and replace a line fuse.



**WARNING**

To avoid potentially lethal shocks, turn off the controller and disconnect it from AC power before performing these procedures.



**CAUTION**

For continued protection against fire hazard, replace the fuse only with the same fuse type and rating specified for the line voltage selected.



**NOTE**

Test the fuse with an ohmmeter. Do not rely on visual inspection of the fuse.

1. Locate the line input assembly on the instrument rear panel. See Figure 8-2.
2. Turn the power switch Off (O).
3. Remove the instrument power cord.
4. With a small screwdriver, release the drawer holding the line voltage selector and fuse.
5. Remove existing fuse(s). Replace them with proper Slow-Blow (time-delay) fuse ratings as follows: 100/120/220/240 V; 3.15 A T 250 V; 5 x 20 mm.
6. Re-assemble the line input assembly in reverse order.
7. Verify that the voltage indicator is in the line input assembly window.
8. Connect the instrument power cord.
9. Turn the power switch On (I).

## 8.7 Factory Reset Menu

It is sometimes necessary to reset instrument parameter values or to clear the contents of curve memory. Both are stored in nonvolatile memory called NOVRAM, but they can be cleared individually. Instrument calibration is not affected except for Room Temperature Calibration, which should be recalibrated after the parameters are set to default values or any time the thermocouple curve is changed.

### 8.7.1 Default Values

The factory defaults can be reset, and the user curves cleared, using the Factory Reset menu. To access the Factory Reset menu, press and hold **Escape** for 5 s. Once the menu appears, select yes or no to the prompt Factory Reset. Selecting yes restores the defaults as listed in TABLE 8-1. Then select yes or no to the prompt Clear Curves, and press **Enter**.

Input setup – general	Default
Sensor type	Diode
Filter	Off
Input name	Input A, Input B
Temperature limit	0 K (Off)
Input units	Kelvin
Curve	DT-670
Input setup – diode	Default
Range	2.5 V (Silicon)
Diode current	10 $\mu$ A
Input setup – platinum/NTC RTD	Default
Autorange	On
Current reversal	On
Input setup – thermocouple	Default
Room comp	On
Room cal	Cleared
Output setup	Default
Output mode	Closed loop PID
Control input	Input A for Output 1; Input B for Output 2
Heater resistance	25 $\Omega$
Power up enable	Off
Heater out display	Current
Setpoint ramping	Off
Display setup	Default
Display mode	Two Input Loop A
Location 1 source	Input A
Location 1 units	Kelvin
Location 2 source	Input B
Location 2 units	Kelvin
Location 3 source	Setpoint 1
Location 3 units	Kelvin
Location 4 source	Output 1
Location 4 units	Kelvin
Brightness	75%

Interface setup	Default
IEEE address	12
Emulation mode	None
Alarm	Default
Alarm	Off
Relay	Default
Relay	Off
Keypad locking	Default
Mode	Unlocked
Lock code	123
PID/manual heater power (MHP) output	Default
Proportional (P)	50.0
Integral (I)	20.0
Derivative (D)	0.0
Manual Output	0.000%
Heater	Default
Heater range	Off
Setpoint	Default
Setpoint value	0.000 K
Remote/local	Default
Remote/local	Local
Zone settings – all zones	Default
Upper boundary	0.000 K
Proportional (P)	50.0
Integral (I)	20.0
Derivative (D)	0.00
Manual output	0.000%
Range	Off
Ramp rate	0.100 K/min
Control input	Default

TABLE 8-1 Default values

## 8.7.2 Product Information

Product information for your instrument is also found in the Factory Reset menu. The following information is provided:

- Firmware version
- Serial number
- Option card type
- Option card serial number

## 8.8 Error Messages

The following are error messages that may be displayed by the Model 335 during operation.

Message	Description
<b>DISABL</b>	Input is disabled. Refer to section 4.4.
<b>NOCURV</b>	Input has no curve. Refer to section 4.4.7.
<b>S.OVER</b>	Input is at or over full-scale sensor units.
<b>S.UNDER</b>	Input is at or under negative full-scale sensor units.
<b>T.OVER</b>	Input at or over the high end of the curve.
<b>T.UNDER</b>	Input at or under the low end of the curve.
<b>Cannot Communicate with Input Processor</b>	The main microprocessor has lost communication with the sensor input microprocessor.
<b>NOVRAM Corrupt, Reset?</b>	Invalid data or contents in NOVRAM—when this message appears. Select Yes to this message and press <b>Enter</b> to reset the factory default values.
<b>**Temp Limit on** **Input A**</b>	The temperature reading on a sensor input has exceeded the Temperature Limit setting.
<b>**Temp Limit on** **Input B**</b>	
<b>** Keypad Locked **</b>	An attempt has been made to change a parameter while the keypad is locked. Refer to section 4.7.
<b>**Heater 1 Short**</b>	A short circuit condition has been observed on one of the heater outputs. The output will be turned off when this occurs.
<b>**Heater 2 Short**</b>	
<b>**Heater 1 Open**</b>	An open circuit condition has been observed on one of the heater outputs.
<b>**Heater 2 Open**</b>	
<b>**Invalid Cal** Press Escape &amp; Enter</b>	The calibration memory is either corrupt, or is at the default, uncalibrated state. This message appears when the Model 335 is first powered on. To clear the message, and continue with instrument start-up, press <b>Escape</b> and <b>Enter</b> simultaneously.
<b>**Invalid Opt Cal** Press Escape &amp; Enter</b>	The installed option card calibration memory is either corrupt, or is at the default, uncalibrated state. This message appears when the Model 335 is first powered on. To clear the message, and continue with instrument start-up, press the <b>Escape</b> and <b>Enter</b> keys simultaneously.
<b>** Firmware Update** **In Progress **</b>	This indicates that the Model 335 is in firmware update mode.
<b>**Htr Circuit Fail** **Output 1**</b>	A hardware failure has been detected on one of the heater output circuits. The heater has been shut down to protect it from further damage.
<b>**Htr Circuit Fail** **Output 2**</b>	

TABLE 8-2 Error messages

## 8.9 Calibration Procedure

Instrument calibration can be obtained through Lake Shore Service. Refer to section 8.14 for technical inquiries and contact information.

### 8.10 Rear Panel Connector Definition

The sensor input, heater output, terminal block, USB, and IEEE-488 connectors are defined in FIGURE 8-3 through FIGURE 8-7. For thermocouple connector details refer to FIGURE 3-7.

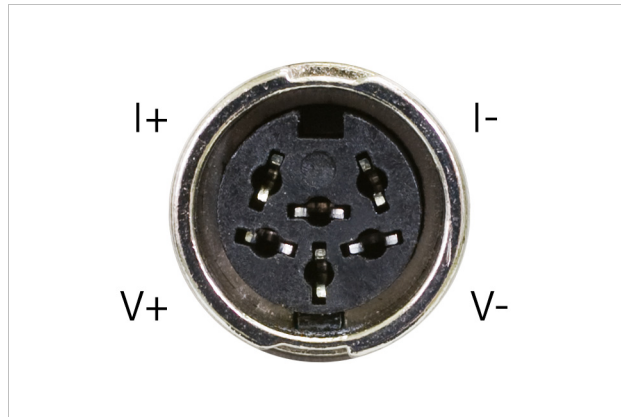

FIGURE 8-3 Sensor input A and B

Pin	Symbol	Description
1	I-	-Current
2	V-	-Voltage
3	None	Shield
4	V+	+Voltage
5	I+	+Current
6	None	Shield

TABLE 8-3 Sensor input A and B connector details



FIGURE 8-4 Heater output connectors

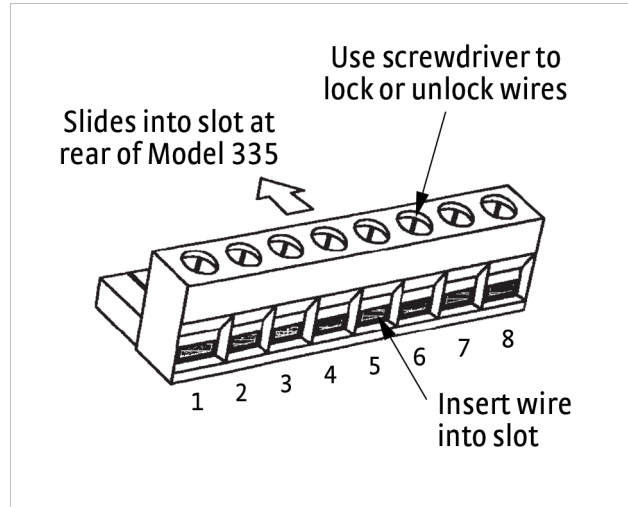

FIGURE 8-5 Terminal block for relays and Output 2 voltage

Pin	Description
1	Output 2+
2	Output 2-
3	Relay 1 normally closed
4	Relay 1 common
5	Relay 1 normally open
6	Relay 2 normally closed
7	Relay 2 common
8	Relay 2 normally open

TABLE 8-4 Terminal block pin and connector details

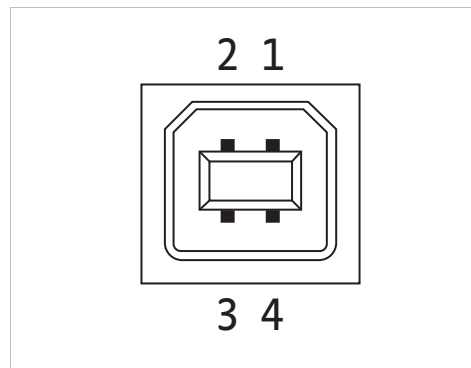

FIGURE 8-6 USB pin and connector details

Pin	Name	Description
1	VCC	+5 VDC
2	D-	Data -
3	D+	Data +
4	GND	Ground

TABLE 8-5 USB pin and connector details

### 8.10.1 IEEE-488 Interface Connector

Connect to the IEEE-488 Interface connector on the Model 335 rear with cables specified in the IEEE-488 standard. The cable has 24 conductors with an outer shield. The connectors are 24-way Amphenol 57 Series (or equivalent) with piggyback receptacles to allow daisy chaining in multiple device systems. The connectors are secured in the receptacles by two captive locking screws with metric threads.

The total length of cable allowed in a system is 2 m for each device on the bus, or 20 m maximum. The Model 335 can drive a bus of up to 10 devices. A connector extender is required to use the IEEE-488 interface and relay terminal block at the same time. FIGURE 8-7 shows the IEEE-488 interface connector pin location and signal names as viewed from the Model 335 rear panel.

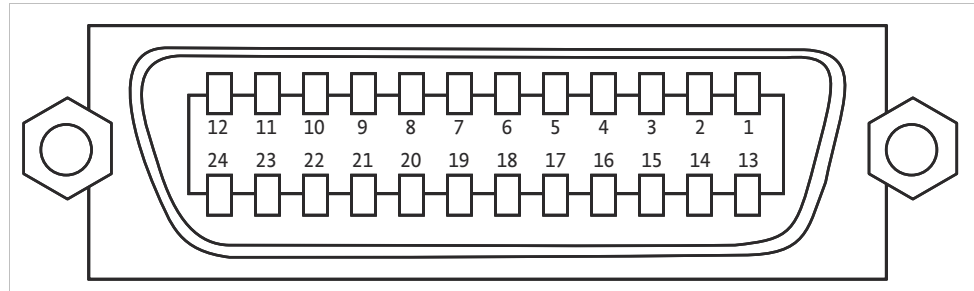

FIGURE 8-7 IEEE-488 interface

Pin	Symbol	Description
1	DIO 1	Data input/output line 1
2	DIO 2	Data input/output line 2
3	DIO 3	Data input/output line 3
4	DIO 4	Data input/output line 4
5	EOI	End or identify
6	DAV	Data valid
7	NRFD	Not ready for data
8	NDAC	No data accepted
9	IFC	Interface clear
10	SRQ	Service request
11	ATN	Attention
12	SHIELD	Cable shield
13	DIO 5	Data input/output line 5
14	DIO 6	Data input/output line 6
15	DIO 7	Data input/output line 7
16	DIO 8	Data input/output line 8
17	REN	Remote enable
18	GND 6	Ground wire: twisted pair with DAV
19	GND 7	Ground wire: twisted pair with NRFD
20	GND 8	Ground wire: twisted pair with NDAC
21	GND 9	Ground wire: twisted pair with IFC
22	GND 10	Ground wire: twisted pair with SRQ
23	GND 11	Ground wire: twisted pair with ATN
24	GND	Logic ground

TABLE 8-6 IEEE-488 rear panel connector details

## 8.11 Electrostatic Discharge

Electrostatic Discharge (ESD) may damage electronic parts, assemblies, and equipment. ESD is a transfer of electrostatic charge between bodies at different electrostatic potentials caused by direct contact or induced by an electrostatic field. The low-energy source that most commonly destroys Electrostatic Discharge sensitive devices is the human body, which generates and retains static electricity. Simply walking across a carpet in low humidity may generate up to 35,000 V of static electricity.

Current technology trends toward greater complexity, increased packaging density, and thinner dielectrics between active elements, which results in electronic devices with even more ESD sensitivity. Some electronic parts are more ESD sensitive than others. ESD levels of only a few hundred volts may damage electronic components such as semiconductors, thick and thin film resistors, and piezoelectric crystals during testing, handling, repair, or assembly. Discharge voltages below 4000 V cannot be seen, felt, or heard.

### 8.11.1 Identification of Electrostatic Discharge Sensitive Components

The following are various industry symbols used to label components as ESD sensitive.



FIGURE 8-8 Symbols indicating ESD sensitivity

### 8.11.2 Handling Electrostatic Discharge Sensitive Components

Observe all precautions necessary to prevent damage to ESDS components before attempting installation. Bring the device and everything that contacts it to ground potential by providing a conductive surface and discharge paths. As a minimum, observe these precautions:

- De-energize or disconnect all power and signal sources and loads used with unit.
- Place unit on a grounded conductive work surface.
- Technician should be grounded through a conductive wrist strap (or other device) using 1 M series resistor to protect operator.
- Ground any tools, such as soldering equipment, that will contact unit. Contact with operator's hands provides a sufficient ground for tools that are otherwise electrically isolated.
- Place ESD sensitive devices and assemblies removed from a unit on a conductive work surface or in a conductive container. An operator inserting or removing a device or assembly from a container must maintain contact with a conductive portion of the container. Use only plastic bags approved for storage of ESD material.
- Do not handle ESD sensitive devices unnecessarily or remove them from the packages until they are actually used or tested.

## 8.12 Model 3060 Installation

The Model 3060 is field-installable. You will need a small Phillips-head screwdriver and the 5/64-in hex driver. Follow this procedure to install the 3060 option.



**To avoid potentially lethal shocks, turn off controller and disconnect it from AC power before performing these procedures.**



**The Model 3060 option card is field installable; however, do not attempt to service other parts of the instrument as they are not user-serviceable. Failure to comply could result in injury or death to the operator.**



## CAUTION

The components on this board are electrostatic discharge sensitive (ESDs) devices. Follow ESD procedures in section 8.11 to avoid inducing an electrostatic discharge (ESD) into the device.

1. Turn the Model 335 power switch Off. Unplug the power cord from the wall outlet, then the instrument.
2. Stand the unit on its face. Use the hex driver to remove the four screws on both sides of the top cover; set aside these screws. Loosen the two rear bottom screws (FIGURE 8-9).

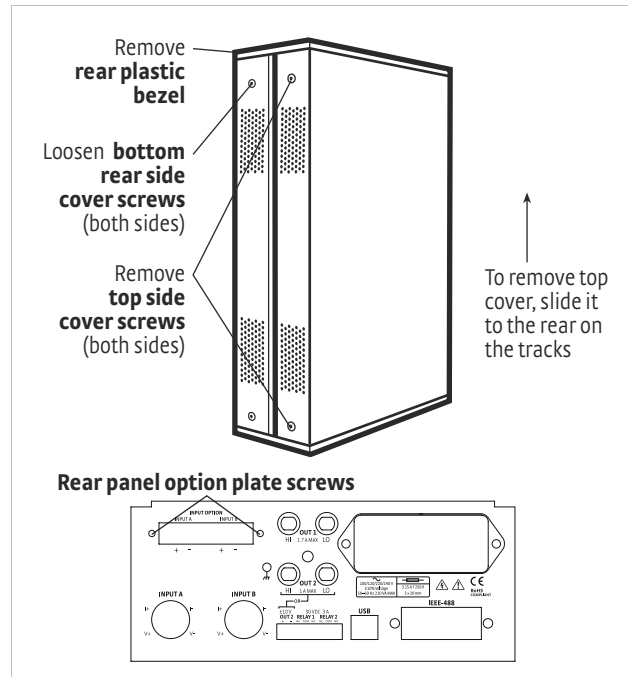

FIGURE 8-9 Cover and option plate screws

3. Remove the rear plastic bezel. The cover is tracked. Slide the top cover to the rear on the track to remove it.
4. Remove the rear panel option plate screws; these screws are not used for the rest of the installation. Remove the rear panel option plate.
5. Lay the instrument on its feet, and turn it to view the inside circuit board.
6. Place the Model 3060 card into its position in the rear panel from inside the instrument. Orient the card so that the circuit board overhang faces the bottom of the instrument.

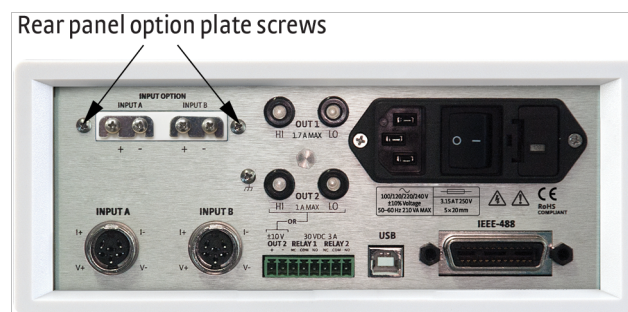

FIGURE 8-10 Align the 3060 card with input A and B

8. Locate the screws included in the 3060 option kit. Attach the card by starting both of these screws in a few threads before tightening either (FIGURE 8-10).
9. Fully tighten both screws.

10. Insert the 14-pin ribbon cable connector plug into the socket on the option board. Orient the ribbon cable connector plug so that the arrow nub slides into the plug slot, and the ribbon cable exits downward (FIGURE 8-11).

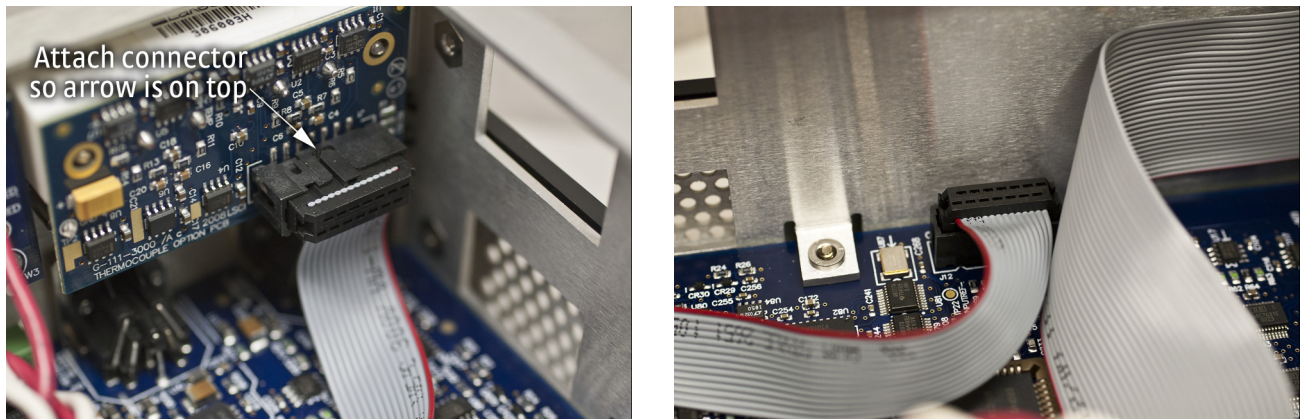

FIGURE 8-11 Proper orientation of the ribbon cable connector plug

11. Plug the other end of the cable into the main board, option connector J12 (FIGURE 8-11).
12. Slide the top panel forward in the track provided on each side of the unit.
13. Replace the rear plastic bezel by sliding it straight into the unit.
14. Use the hex driver to replace the four screws on the sides of the top covers. Tighten the two rear bottom screws.

## **!WARNING**

**Do not to apply power to the instrument until it has been fully reassembled. Failure to comply could result in injury or death to the operator.**

15. Replace the power cord in the rear of the unit and set the power switch to On.
16. To verify option card installation, check the instrument information. Refer to section 8.7.2 for more information on instrument information.

## 8.13 Firmware Updates

### 8.13.1 Updating the Firmware

This section provides instructions for updating the firmware in your instrument.

Periodically Lake Shore provides updates to instrument firmware. The files for these updates can be downloaded from our website. To access the firmware updates, follow this procedure.

1. Go to <http://www.lakeshore.com/products/cryogenic-temperature-controllers/model-335/Pages/Overview.aspx> to download the instrument firmware.
2. Enter your name and email address so that we can keep you updated on any new firmware for your instrument.
3. Click the “Go to the download” bar and follow the prompts that are provided on the screen for you.

## 8.14 Technical Inquiries

Refer to the following sections when contacting Lake Shore for application assistance or product service. Questions regarding product applications, price, availability and shipments should be directed to sales. Questions regarding instrument calibration or repair should be directed to instrument service. Do not return a product to Lake Shore without a Return Material Authorization (RMA) number (section 8.14.2).

### 8.14.1 Contacting Lake Shore

The Lake Shore Service Department is staffed Monday through Friday between the hours of 8:00 AM and 5:00 PM EST, excluding holidays and company shut down days.

Contact Lake Shore Service through any of the means listed below. However, the most direct and efficient means of contacting is to complete the online service request form at <http://www.lakeshore.com/sup/serf.html>. Provide a detailed description of the problem and the required contact information. You will receive a response within 24 hours or the next business day in the event of weekends or holidays.

If you wish to contact Service or Sales by mail or telephone, use the following:

<b>Mailing address</b>	Lake Shore Cryotronics Instrument Service Department 575 McCorkle Blvd. Westerville, Ohio USA 43082-8888	
<b>E-mail address</b>	<a href="mailto:sales@lakeshore.com">sales@lakeshore.com</a> <a href="mailto:service@lakeshore.com">service@lakeshore.com</a>	Sales Instrument Service
<b>Telephone</b>	614-891-2244 614-891-2243 select the option for Service	Sales Instrument Service
<b>Fax</b>	614-818-1600 614-818-1609	Sales Instrument Service
<b>Web service request</b>	<a href="http://www.lakeshore.com/sup/serf.html">http://www.lakeshore.com/sup/serf.html</a>	Instrument Service

TABLE 8-7 Contact information

### 8.14.2 Return of Equipment

The temperature controller is packaged to protect it during shipment.



**The user should retain any shipping carton(s) in which equipment is originally received, in the event that any equipment needs to be returned.**

If original packaging is not available, a minimum of 76.2 mm (3 in) of shock absorbent packing material should be placed snugly on all sides of the instrument in a sturdy corrugated cardboard box. Please use reasonable care when removing the temperature controller from its protective packaging and inspect it carefully for damage. If it shows any sign of damage, please file a claim with the carrier immediately. Do not destroy the shipping container; it will be required by the carrier as evidence to support claims. Call Lake Shore for return and repair instructions.

All equipment returns must be approved by a member of the Lake Shore Service Department. The service engineer will use the information provided in the service request form and will issue an RMA. This number is necessary for all returned equipment. It must be clearly indicated on both the shipping carton(s) and any correspondence relating to the shipment. Once the RMA has been approved, you will receive appropriate documents and instructions for shipping the equipment to Lake Shore.

### 8.14.3 RMA Valid Period

RMAs are valid for 60 days from issuance; however, we suggest that equipment needing repair be shipped to Lake Shore within 30 days after the RMA has been issued. You will be contacted if we do not receive the equipment within 30 days after the RMA is issued. The RMA will be cancelled if we do not receive the equipment after 60 days.

#### 8.14.4 Shipping Charges

All shipments to Lake Shore are to be made prepaid by the customer. Equipment serviced under warranty will be returned prepaid by Lake Shore. Equipment serviced out-of-warranty will be returned FOB Lake Shore.

#### 8.14.5 Restocking Fee

Lake Shore reserves the right to charge a restocking fee for items returned for exchange or reimbursement.



# Appendix A: Temperature Scales

## A.1 Definition

Temperature is a fundamental unit of measurement that describes the kinetic and potential energies of the atoms and molecules of bodies. When the energies and velocities of the molecules in a body are increased, the temperature is increased whether the body is a solid, liquid, or gas. Thermometers are used to measure temperature. The temperature scale is based on the temperature at which ice, liquid water, and water vapor are all in equilibrium. This temperature is called the triple point of water and is assigned the value 0 °C, 32 °F, and 273.15 K. These three temperature scales are defined as follows:

- **Celsius:** abbreviation: °C. A temperature scale that registers the freezing point of water as 0 °C and the boiling point as 100 °C under normal atmospheric pressure. Formerly known as Centigrade. Originally devised by Anders Celsius (1701 - 1744), a Swedish astronomer.
- **Fahrenheit:** abbreviation: °F. A temperature scale that registers the freezing point of water as 32 °F and the boiling point as 212 °F under normal atmospheric pressure. Originally devised by Gabriel Fahrenheit (1686 - 1736), a German physicist residing in Holland; developed use of mercury in thermometry.
- **Kelvin:** abbreviation: K. An absolute scale of temperature, the zero point of which is approximately
- **-273.15°C:** scale units are equal in magnitude to Celsius degrees. Originally devised by Lord Kelvin, William Thompson, (1824 - 1907), a British physicist, mathematician, and inventor.

## A.2 Comparison

The three temperature scales are graphically compared in Figure A-1.

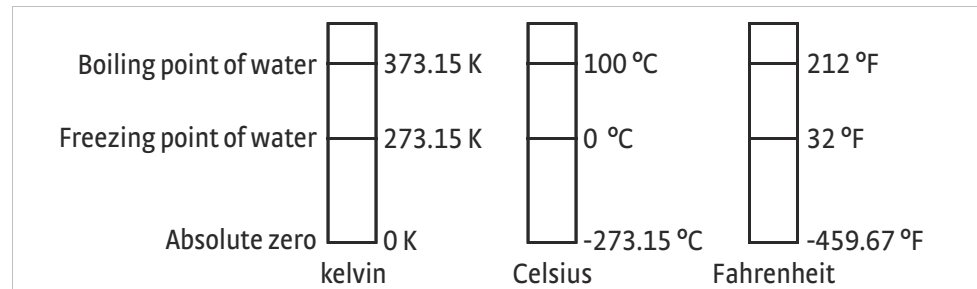

FIGURE A-1

## A.3 Conversions

To convert Fahrenheit to Celsius: subtract 32 from °F then divide by 1.8, or:

$$^{\circ}\text{C} = (^{\circ}\text{F} - 32) \div 1.8$$

To convert Celsius to Fahrenheit: multiply °C by 1.8 then add 32, or:

$$^{\circ}\text{F} = (1.8 \times ^{\circ}\text{C}) + 32$$

To convert Fahrenheit to kelvin, first convert °F to °C, then add 273.15.

To convert Celsius to kelvin, add 273.15.

°F	°C	K	°F	°C	K	°F	°C	K
-459.67	-273.15	0	-292	-180	93.15	-129.67	-89.82	183.33
-454	-270	3.15	-290	-178.89	94.26	-120	-84.44	188.71
-450	-267.78	5.37	-289.67	-178.71	94.44	-119.67	-84.44	188.89
-449.67	-267.59	5.56	-280	-173.33	99.82	-117.67	-83.15	190
-441.67	-263.15	10	-279.67	-173.15	100	-112	-80	193.15
-440	-262.22	10.93	-274	-170	103.15	-110	-78.89	194.26
-439.67	-262.04	11.11	-270	-167.78	105.57	-109.67	-78.71	194.44
-436	-260	13.15	-269.67	-167.59	105.56	-100	-73.33	199.82
-430	-256.67	16.48	-261.67	-163.15	110	-99.67	-73.15	200
-429.67	-256.48	16.67	-260	-162.22	110.93	-94	-70	203.15
-423.67	-253.15	20	-259.67	-162.04	111.11	-90	-67.78	205.37
-420	-251.11	22.04	-256	-160	113.15	-89.67	-67.59	205.56
-419.67	-250.93	22.22	-250	-156.67	116.48	-81.67	-63.15	210
-418.00	-250	23.15	-249.67	-156.48	116.67	-80	-62.22	210.93
-410	-245.56	27.59	-243.67	-153.15	120	-79.67	-62.04	211.11
-409.67	-245.37	27.78	-240	-151.11	122.04	-76	-60	213.15
-405.67	-243.15	30	-239.67	-150.93	122.22	-70	-56.67	216.48
-400	-240	33.15	-238	-150	123.15	-69.67	-56.48	216.67
-399.67	-239.82	33.33	-230	-145.56	127.59	-63.67	-53.15	220
-390	-234.44	38.71	-229.67	-145.37	127.78	-60	-51.11	222.04
-389.67	-234.26	38.89	-225.67	-143.15	130	-59.67	-50.93	222.22
-387.67	-233.15	40	-220	-140	133.15	-58	-50	223.15
-382	-230	43.15	-219.67	-139.82	133.33	-50	-45.56	227.59
-380	-228.89	44.26	-210	-134.44	138.71	-49.67	-45.37	227.78
-379.67	-228.71	44.44	-209.67	-134.26	138.89	-45.67	-43.15	230
-370	-223.33	49.82	-207.67	-133.15	140	-40	-40	233.15
369.67	-223.15	50	-202	-130	143.15	-39.67	-39.82	233.33
-364	-220	53.15	-200	-128.89	144.26	-30	-34.44	238.71
-360	-217.78	55.37	-199.67	-128.71	144.44	-29.67	-34.26	238.89
-359.67	-217.59	55.56	-190	-123.33	149.82	-27.67	-33.15	240
-351.67	-213.15	60	-189.67	-123.15	150	-22	-30	243.15
-350	-212.22	60.93	-184	-120	153.15	-20	-28.89	244.26
-349.67	-212.04	61.11	-180	-117.78	155.37	-19.67	-28.71	244.44
-346	-210	63.15	-179.67	-117.59	155.56	-10	-23.33	249.82
-340	-206.67	66.48	-171.67	-113.15	160	-9.67	-23.15	250
-339.67	-206.48	66.67	-170	-112.22	-160.93	-4	-20	253.15
-333.67	-203.15	70	-169.67	-112.04	161.11	0	-17.78	255.37
-330	-201.11	72.04	-166	-110	163.15	+0.33	-17.59	255.56
-329.67	-200.93	72.22	-160	-106.67	166.48	8.33	-13.15	260
-328	-200	73.15	-159.67	-106.48	166.67	10	-12.22	260.93
-320	-195.56	77.59	-153.67	-103.15	170	10.33	-12.04	261.11
-319.67	-195.37	77.78	-150	-101.11	172.04	14	-10	263.15
-315.67	-193.15	80	-149.67	-100.93	172.22	20	-6.67	266.48
-310	-190	83.15	-148	-100	173.15	20.33	-6.48	266.67
-309.67	-189.82	83.33	-140	-95.96	177.59	26.33	-3.15	270
-300	-184.44	88.71	-139.67	-95.37	177.78	30	-1.11	272.04
-299.67	-184.26	88.89	-135.67	-93.15	180	30.33	-0.93	272.22
-297.67	-183.15	90	-130	-90	183.15	32	0	273.15

TABLE A-1 Temperature conversions

# Appendix B: Handling Liquid Helium and Nitrogen

## B.1 General

Use of liquid helium (LHe) and liquid nitrogen (LN<sub>2</sub>) is often associated with the Model 335 temperature controller. Although not explosive, there are a number of safety considerations to keep in mind in the handling of LHe and LN<sub>2</sub>.

## B.2 Properties

LHe and LN<sub>2</sub> are colorless, odorless, and tasteless gases. Gaseous nitrogen makes up about 78 percent of the Earth's atmosphere, while helium comprises only about 5 ppm. Most helium is recovered from natural gas deposits. Once collected and isolated, the gases will liquefy when properly cooled. A quick comparison between LHe and LN<sub>2</sub> is provided in TABLE B-1.

Property	Liquid Helium	Liquid Nitrogen
Boiling Point at 1 atm	4.2 K	77 K
Thermal Conductivity (Gas), w/cm-K	0.083	0.013
Latent Heat of Vaporization, Btu/L	2.4	152
Liquid Density, lb/L	0.275	0.78

TABLE B-1 Comparison of liquid helium and liquid nitrogen

## B.3 Handling Cryogenic Storage Dewars

Cryogenic containers (Dewars) must be operated in accordance with the manufacturer instructions. Safety instructions will also be posted on the side of each Dewar. Cryogenic Dewars must be kept in a well-ventilated place where they are protected from the weather and away from any sources of heat. A typical cryogenic Dewar is shown in FIGURE B-1.

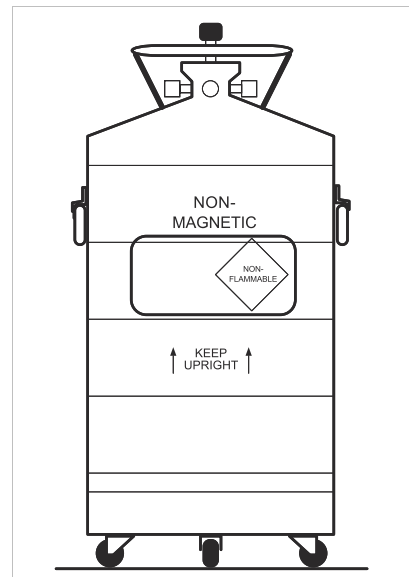

FIGURE B-1 Typical cryogenic storage Dewar

## B.4 Liquid Helium and Nitrogen Safety Precautions

Transferring LHe and LN<sub>2</sub> and operation of the storage Dewar controls should be in accordance with the manufacturer/supplier's instructions. During this transfer, it is important that all safety precautions written on the storage Dewar and recommended by the manufacturer be followed.





Liquid helium and liquid nitrogen are potential asphyxiants and can cause rapid suffocation without warning. Store and use in area with adequate ventilation. DO NOT vent container in confined spaces. DO NOT enter confined spaces where gas may be present unless area has been well ventilated. If inhaled, remove to fresh air. If not breathing, give artificial respiration. If breathing is difficult, give oxygen. Get medical help.



Liquid helium and liquid nitrogen can cause severe frostbite to the eyes or skin. DO NOT touch frosted pipes or valves. In case of frostbite, consult a physician at once. If a physician is not readily available, warm the affected areas with water that is near body temperature.

The two most important safety aspects to consider when handling LHe and LN<sub>2</sub> are adequate ventilation and eye and skin protection. Although helium and nitrogen gases are non-toxic, they are dangerous in that they replace the air in a normal breathing atmosphere. Liquid products are of an even greater threat since a small amount of liquid evaporates to create a large amount of gas. Therefore, it is imperative that cryogenic Dewars be stored and the MTD system be operated in open and well ventilated areas.

Persons transferring LHe and LN<sub>2</sub> should make every effort to protect eyes and skin from accidental contact with liquid or the cold gas issuing from it. Protect your eyes with full-face shield or chemical splash goggles. Safety glasses (even with side shields) are not adequate. Always wear special cryogenic gloves (Tempshield Cryo-Gloves® or equivalent) when handling anything that is, or may have been, in contact with the liquid or cold gas, or with cold pipes or equipment. Long sleeve shirts and cuffless trousers that are of sufficient length to prevent liquid from entering the shoes are recommended.

## B.5 Recommended First Aid

Every site that stores and uses LHe and LN<sub>2</sub> should have an appropriate Material Safety Data Sheet (MSDS) present. The MSDS may be obtained from the manufacturer/distributor. The MSDS will specify the symptoms of overexposure and the first aid to be used. A typical summary of these instructions is provided as follows.

If symptoms of asphyxia such as headache, drowsiness, dizziness, excitation, excess salivation, vomiting, or unconsciousness are observed, remove the victim to fresh air. If breathing is difficult, give oxygen. If breathing has stopped, give artificial respiration. Call a physician immediately.

If exposure to cryogenic liquids or cold gases occurs, restore tissue to normal body temperature (98.6 °F) as rapidly as possible, then protect the injured tissue from further damage and infection. Call a physician immediately. Rapid warming of the affected parts is best achieved by bathing it in warm water. The water temperature should not exceed 105 °F (40 °C), and under no circumstances should the frozen part be rubbed, either before or after rewarming. If the eyes are involved, flush them thoroughly with warm water for at least 15 minutes. In case of massive exposure, remove clothing while showering with warm water. The patient should not drink alcohol or smoke. Keep warm and rest. Call a physician immediately.

# Appendix C: Curve Tables

## C.1 General

Standard curve tables included in the Model 335 temperature controller are as follows:

Curve Location	Model	Table
Curve 01	DT-470 Silicon Diode	Table D-1
Curve 02	DT-670 Silicon Diode	Table D-2
Curve 03 & 04	DT-500-D/-E1 Silicon Diode	Table D-3
Curve 06 & 07	PT-100/-1000 Platinum RTD	Table D-4
Curve 08	RX-102A Rox™	Table D-5
Curve 09	RX-202A Rox™	Table D-6
Curve 12	Type K Thermocouple	Table D-7
Curve 13	Type E Thermocouple	Table D-8
Curve 14	Type T Thermocouple	Table D-9
Curve 15	Chromel-AuFe 0.03% Thermocouple	Table D-10
Curve 16	Chromel-AuFe 0.07% Thermocouple	Table D-11

TABLE C-1

Breakpoint	Temp (K)	Volts	Breakpoint	Temp (K)	Volts	Breakpoint	Temp (K)	Volts
1	475.0	0.09062	30	170.0	0.82405	59	031.0	1.10476
2	470.0	0.11191	31	160.0	0.84651	60	030.0	1.10702
3	465.0	0.11356	32	150.0	0.86874	61	029.0	1.10945
4	460.0	0.12547	33	145.0	0.87976	62	028.0	1.11212
5	455.0	0.13759	34	140.0	0.89072	63	027.0	1.11517
6	450.0	0.14985	35	135.0	0.90161	64	026.0	1.11896
7	445.0	0.16221	36	130.0	0.91243	65	025.0	1.12463
8	440.0	0.17464	37	125.0	0.92317	66	024.0	1.13598
9	435.0	0.18710	38	120.0	0.93383	67	023.0	1.15558
10	430.0	0.19961	39	115.0	0.94440	68	022.0	1.17705
11	420.0	0.22463	40	110.0	0.95487	69	021.0	1.19645
12	410.0	0.24964	41	105.0	0.96524	70	019.5	1.22321
13	400.0	0.27456	42	100.0	0.97550	71	017.0	1.26685
14	395.0	0.28701	43	095.0	0.98564	72	015.0	1.30404
15	380.0	0.32417	44	090.0	0.99565	73	013.5	1.33438
16	365.0	0.36111	45	085.0	1.00552	74	012.5	1.35642
17	345.0	0.41005	46	080.0	1.01525	75	011.5	1.38012
18	330.0	0.44647	47	075.0	1.02482	76	010.5	1.40605
19	325.0	0.45860	48	070.0	1.03425	77	009.5	1.43474
20	305.0	0.50691	49	065.0	1.04353	78	008.5	1.46684
21	300.0	0.51892	50	058.0	1.05630	79	007.5	1.50258
22	285.0	0.55494	51	052.0	1.06702	80	005.2	1.59075
23	265.0	0.60275	52	046.0	1.07750	81	004.2	1.62622
24	250.0	0.63842	53	040.0	1.08781	82	003.4	1.65156
25	235.0	0.67389	54	039.0	1.08953	83	002.6	1.67398
26	220.0	0.70909	55	036.0	1.09489	84	002.1	1.68585
27	205.0	0.74400	56	034.0	1.09864	85	001.7	1.69367
28	190.0	0.77857	57	033.0	1.10060	86	001.4	1.69818
29	180.0	0.80139	58	032.0	1.10263			

TABLE C-2 Lake Shore DT-470 Silicon Diode (Curve 01)

Breakpoint	Volts	Temp (K)	Breakpoint	Volts	Temp (K)	Breakpoint	Volts	Temp (K)
1	0.090570	500.00	26	1.01064	87.0	51	1.19475	20.2
2	0.110239	491.0	27	1.02125	81.0	52	1.24208	17.10
3	0.136555	479.5	28	1.03167	75.0	53	1.26122	15.90
4	0.179181	461.5	29	1.04189	69.0	54	1.27811	14.90
5	0.265393	425.5	30	1.05192	63.0	55	1.29430	14.00
6	0.349522	390.0	31	1.06277	56.4	56	1.31070	13.15
7	0.452797	346.0	32	1.07472	49.0	57	1.32727	12.35
8	0.513393	320.0	33	1.09110	38.7	58	1.34506	11.55
9	0.563128	298.5	34	1.09602	35.7	59	1.36423	10.75
10	0.607845	279.0	35	1.10014	33.3	60	1.38361	10.0
11	0.648723	261.0	36	1.10393	31.2	61	1.40454	9.25
12	0.686936	244.0	37	1.10702	29.6	62	1.42732	8.50
13	0.722511	228.0	38	1.10974	28.3	63	1.45206	7.75
14	0.755487	213.0	39	1.11204	27.3	64	1.48578	6.80
15	0.786992	198.5	40	1.11414	26.5	65	1.53523	5.46
16	0.817025	184.5	41	1.11628	25.8	66	1.56684	4.56
17	0.844538	171.5	42	1.11853	25.2	67	1.58358	4.04
18	0.869583	159.5	43	1.12090	24.7	68	1.59690	3.58
19	0.893230	148.0	44	1.12340	24.3	69	1.60756	3.18
20	0.914469	137.5	45	1.12589	24.0	70	1.62125	2.62
21	0.934356	127.5	46	1.12913	23.7	71	1.62945	2.26
22	0.952903	118.0	47	1.13494	23.3	72	1.63516	1.98
23	0.970134	109.0	48	1.14495	22.8	73	1.63943	1.74
24	0.986073	100.5	49	1.16297	22.0	74	1.64261	1.53
25	0.998925	93.5	50	1.17651	21.3	75	1.64430	1.40

TABLE C-3 Standard DT-670 diode curve

Breakpoint	DT-500-D Curve		DT-500-E1 Curve	
	Temp (K)	Volts	Temp (K)	Volts
1	365.0	0.19083	330.0	0.28930
2	345.0	0.24739	305.0	0.36220
3	305.0	0.36397	285.0	0.41860
4	285.0	0.42019	265.0	0.47220
5	265.0	0.47403	240.0	0.53770
6	240.0	0.53960	220.0	0.59260
7	220.0	0.59455	170.0	0.73440
8	170.0	0.73582	130.0	0.84490
9	130.0	0.84606	100.0	0.92570
10	090.0	0.95327	075.0	0.99110
11	070.0	1.00460	060.0	1.02840
12	055.0	1.04070	040.0	1.07460
13	040.0	1.07460	036.0	1.08480
14	034.0	1.09020	034.0	1.09090
15	032.0	1.09700	032.0	1.09810
16	030.0	1.10580	030.0	1.10800
17	029.0	1.11160	029.0	1.11500
18	028.0	1.11900	028.0	1.12390
19	027.0	1.13080	027.0	1.13650
20	026.0	1.14860	026.0	1.15590
21	025.0	1.17200	025.0	1.18770
22	023.0	1.25070	024.0	1.23570

TABLE C-4 Lake Shore DT-500 series silicon diode curves (no longer in production)

Breakpoint	DT-500-D Curve		DT-500-E1 Curve	
	Temp (K)	Volts	Temp (K)	Volts
23	021.0	1.35050	022.0	1.32570
24	017.0	1.63590	018.0	1.65270
25	015.0	1.76100	013.0	1.96320
26	013.0	1.90660	009.0	2.17840
27	009.0	2.11720	004.0	2.53640
28	003.0	2.53660	003.0	2.59940
29	001.4	2.59840	001.4	2.65910

TABLE C-4 Lake Shore DT-500 series silicon diode curves (no longer in production)

Breakpoint	PT-100		PT-1000	
	Temp (K)	Ohms ( $\Omega$ )	Temp (K)	Ohms ( $\Omega$ )
1	030.0	3.820	030.0	38.20
2	032.0	4.235	032.0	42.35
3	036.0	5.146	036.0	51.46
4	038.0	5.650	038.0	56.50
5	040.0	6.170	040.0	61.70
6	042.0	6.726	042.0	67.26
7	046.0	7.909	046.0	79.09
8	052.0	9.924	052.0	99.24
9	058.0	12.180	058.0	121.80
10	065.0	15.015	065.0	150.15
11	075.0	19.223	075.0	192.23
12	085.0	23.525	085.0	235.25
13	105.0	32.081	105.0	320.81
14	140.0	46.648	140.0	466.48
15	180.0	62.980	180.0	629.80
16	210.0	75.044	210.0	750.44
17	270.0	98.784	270.0	987.84
18	315.0	116.270	315.0	1162.70
19	355.0	131.616	355.0	1316.16
20	400.0	148.652	400.0	1486.52
21	445.0	165.466	445.0	1654.66
22	490.0	182.035	490.0	1820.35
23	535.0	198.386	535.0	1983.86
24	585.0	216.256	585.0	2162.56
25	630.0	232.106	630.0	2321.06
26	675.0	247.712	675.0	2477.12
27	715.0	261.391	715.0	2613.91
28	760.0	276.566	760.0	2765.66
29	800.0	289.830	800.0	2898.30

TABLE C-5 Lake Shore PT-100/-1000 platinum RTD curves

Breakpoint	log $\Omega$	Temp (K)	Breakpoint	log $\Omega$	Temp (K)	Breakpoint	log $\Omega$	Temp (K)
1	3.02081	40.0	36	3.05186	13.50	71	3.17838	2.96
2	3.02133	38.8	37	3.05322	13.10	72	3.18540	2.81
3	3.02184	37.7	38	3.05466	12.70	73	3.19253	2.67
4	3.02237	36.6	39	3.05618	12.30	74	3.20027	2.53
5	3.02294	35.5	40	3.05780	11.90	75	3.20875	2.39
6	3.02353	34.4	41	3.05952	11.50	76	3.21736	2.26
7	3.02411	33.4	42	3.06135	11.10	77	3.22675	2.13
8	3.02472	32.4	43	3.06330	10.70	78	3.23707	2.00
9	3.02537	31.4	44	3.06537	10.30	79	3.24842	1.87
10	3.02605	30.4	45	3.06760	9.90	80	3.26000	1.75
11	3.02679	29.4	46	3.06968	9.55	81	3.27169	1.64
12	3.02749	28.5	47	3.07190	9.20	82	3.28462	1.53
13	3.02823	27.6	48	3.07428	8.85	83	3.29779	1.43
14	3.02903	26.7	49	3.07685	8.50	84	3.31256	1.33
15	3.02988	25.8	50	3.07922	8.20	85	3.32938	1.23
16	3.03078	24.9	51	3.08175	7.90	86	3.34846	1.130
17	3.03176	24.0	52	3.08447	7.60	87	3.37196	1.020
18	3.03280	23.1	53	3.08786	7.25	88	3.39220	0.935
19	3.03393	22.2	54	3.09150	6.90	89	3.41621	0.850
20	3.03500	21.4	55	3.09485	6.60	90	3.44351	0.765
21	3.03615	20.6	56	3.09791	6.35	91	3.47148	0.690
22	3.03716	19.95	57	3.10191	6.05	92	3.50420	0.615
23	3.03797	19.45	58	3.10638	5.74	93	3.54057	0.545
24	3.03882	18.95	59	3.11078	5.46	94	3.58493	0.474
25	3.03971	18.45	60	3.11558	5.18	95	3.63222	0.412
26	3.04065	17.95	61	3.12085	4.90	96	3.68615	0.354
27	3.04164	17.45	62	3.12622	4.64	97	3.75456	0.295
28	3.04258	17.00	63	3.13211	4.38	98	3.82865	0.245
29	3.04357	16.55	64	3.13861	4.12	99	3.91348	0.201
30	3.04460	16.10	65	3.14411	3.92	100	4.01514	0.162
31	3.04569	15.65	66	3.14913	3.75	101	4.14432	0.127
32	3.04685	15.20	67	3.15454	3.58	102	4.34126	0.091
33	3.04807	14.75	68	3.16002	3.42	103	4.54568	0.066
34	3.04936	14.30	69	3.16593	3.26	104	4.79803	0.050
35	3.05058	13.90	70	3.17191	3.11			

TABLE C-6 Lake Shore RX-102A Rox™ curve

Breakpoint	log $\Omega$	Temp (K)	Breakpoint	log $\Omega$	Temp (K)	Breakpoint	log $\Omega$	Temp (K)
1	3.35085	40.0	34	3.40482	11.45	67	3.52772	2.17
2	3.35222	38.5	35	3.40688	11.00	68	3.53459	2.04
3	3.35346	37.2	36	3.40905	10.55	69	3.54157	1.92
4	3.35476	35.9	37	3.41134	10.10	70	3.54923	1.80
5	3.35612	34.6	38	3.41377	9.65	71	3.55775	1.68
6	3.35755	33.3	39	3.41606	9.25	72	3.56646	1.57
7	3.35894	32.1	40	3.41848	8.85	73	3.57616	1.46
8	3.36039	30.9	41	3.42105	8.45	74	3.58708	1.35
9	3.36192	29.7	42	3.42380	8.05	75	3.59830	1.25
10	3.36340	28.6	43	3.42637	7.70	76	3.61092	1.150
11	3.36495	27.5	44	3.42910	7.35	77	3.62451	1.055
12	3.36659	26.4	45	3.43202	7.00	78	3.63912	0.965
13	3.36831	25.3	46	3.43515	6.65	79	3.65489	0.880
14	3.37014	24.2	47	3.43853	6.30	80	3.67206	0.800
15	3.37191	23.2	48	3.44230	5.94	81	3.69095	0.725
16	3.37377	22.2	49	3.44593	5.62	82	3.71460	0.645
17	3.37575	21.2	50	3.44984	5.30	83	3.73889	0.575
18	3.37785	20.2	51	3.45355	5.02	84	3.76599	0.510
19	3.37942	19.50	52	3.45734	4.76	85	3.79703	0.448
20	3.38081	18.90	53	3.46180	4.48	86	3.83269	0.390
21	3.38226	18.30	54	3.46632	4.22	87	3.87369	0.336
22	3.38377	17.70	55	3.47012	4.02	88	3.92642	0.281
23	3.38522	17.15	56	3.47357	3.85	89	3.98609	0.233
24	3.38672	16.60	57	3.47726	3.68	90	4.05672	0.190
25	3.38829	16.05	58	3.48122	3.51	91	4.14042	0.153
26	3.38993	15.50	59	3.48524	3.35	92	4.24807	0.120
27	3.39165	14.95	60	3.48955	3.19	93	4.40832	0.088
28	3.39345	14.40	61	3.49421	3.03	94	4.57858	0.067
29	3.39516	13.90	62	3.49894	2.88	95	4.76196	0.055
30	3.39695	13.40	63	3.50406	2.73	96	4.79575	0.051
31	3.39882	12.90	64	3.50962	2.58	97	4.81870	0.050
32	3.40079	12.40	65	3.51528	2.44			
33	3.40286	11.90	66	3.52145	2.30			

TABLE C-7 Lake Shore RX-202A Rox™ curve

Break-point	mV	Temp (K)	Break-point	mV	Temp (K)	Break-point	mV	Temp (K)	Break-point	mV	Temp (K)
1	-6.45774	3.15	48	-6.10828	57.4	95	-2.95792	192	142	18.1482	714.5
2	-6.45733	3.68	49	-6.08343	59.4	96	-2.82629	196	143	19.2959	741.5
3	-6.45688	4.2	50	-6.05645	61.5	97	-2.6762	200.5	144	20.8082	777
4	-6.45632	4.78	51	-6.02997	63.5	98	-2.52392	205	145	23.1752	832.5
5	-6.45565	5.4	52	-6.00271	65.5	99	-2.36961	209.5	146	24.5166	864
6	-6.45494	6	53	-5.97469	67.5	100	-2.21329	214	147	25.6001	889.5
7	-6.4541	6.65	54	-5.94591	69.5	101	-2.05503	218.5	148	26.5536	912
8	-6.4531	7.35	55	-5.91637	71.5	102	-1.87703	223.5	149	27.4199	932.5
9	-6.45201	8.05	56	-5.8861	73.5	103	-1.69672	228.5	150	28.2413	952
10	-6.45073	8.8	57	-5.85508	75.5	104	-1.51427	233.5	151	29.0181	970.5
11	-6.44934	9.55	58	-5.82334	77.5	105	-1.32972	238.5	152	29.7714	988.5
12	-6.44774	10.35	59	-5.78268	80	106	-1.12444	244	153	30.5011	1006
13	-6.44601	11.15	60	-5.74084	82.5	107	-0.91675	249.5	154	31.2074	1023
14	-6.44403	12	61	-5.69792	85	108	-0.70686	255	155	31.8905	1039.5
15	-6.44189	12.85	62	-5.6539	87.5	109	-0.47553	261	156	32.571	1056
16	-6.43947	13.75	63	-5.60879	90	110	-0.22228	267.5	157	33.2489	1072.5
17	-6.43672	14.7	64	-5.5626	92.5	111	0.053112	274.5	158	33.9038	1088.5
18	-6.43378	15.65	65	-5.51535	95	112	0.350783	282	159	34.5561	1104.5
19	-6.43065	16.6	66	-5.46705	97.5	113	0.651006	289.5	160	35.2059	1120.5
20	-6.42714	17.6	67	-5.4177	100	114	0.973714	297.5	161	35.8532	1136.5
21	-6.42321	18.65	68	-5.36731	102.5	115	1.31919	306	162	36.4979	1152.5
22	-6.41905	19.7	69	-5.3159	105	116	1.70801	315.5	163	37.14	1168.5
23	-6.41442	20.8	70	-5.26348	107.5	117	2.14052	326	164	37.7596	1184
24	-6.40952	21.9	71	-5.19928	110.5	118	2.69954	339.5	165	38.3767	1199.5
25	-6.40435	23	72	-5.13359	113.5	119	3.75883	365	166	38.9915	1215
26	-6.39841	24.2	73	-5.06651	116.5	120	4.29687	378	167	39.6038	1230.5
27	-6.39214	25.4	74	-4.99801	119.5	121	4.74986	389	168	40.2136	1246
28	-6.38554	26.6	75	-4.92813	122.5	122	5.17977	399.5	169	40.821	1261.5
29	-6.37863	27.8	76	-4.85687	125.5	123	5.60705	410	170	41.4063	1276.5
30	-6.37077	29.1	77	-4.78426	128.5	124	6.03172	420.5	171	41.9893	1291.5
31	-6.36253	30.4	78	-4.71031	131.5	125	6.49428	432	172	42.5699	1306.5
32	-6.35391	31.7	79	-4.63503	134.5	126	7.09465	447	173	43.1288	1321
33	-6.34422	33.1	80	-4.55845	137.5	127	8.15226	473.5	174	43.6853	1335.5
34	-6.33408	34.5	81	-4.48056	140.5	128	8.75291	488.5	175	44.2394	1350
35	-6.3235	35.9	82	-4.38814	144	129	9.25576	501	176	44.7721	1364
36	-6.3117	37.4	83	-4.29393	147.5	130	9.74087	513	177	45.3024	1378
37	-6.29939	38.9	84	-4.19806	151	131	10.2285	525	178	45.8114	1391.5
38	-6.2866	40.4	85	-4.10051	154.5	132	10.7186	537	179	46.3182	1405
39	-6.27241	42	86	-4.00133	158	133	11.2317	549.5	180	46.8038	1418
40	-6.25768	43.6	87	-3.90053	161.5	134	11.7883	563	181	47.2873	1431
41	-6.24239	45.2	88	-3.79815	165	135	12.3888	577.5	182	47.7684	1444
42	-6.22656	46.8	89	-3.6942	168.5	136	13.054	593.5	183	48.2287	1456.5
43	-6.21019	48.4	90	-3.58873	172	137	13.7844	611	184	48.6868	1469
44	-6.19115	50.2	91	-3.46638	176	138	14.5592	629.5	185	49.1426	1481.5
45	-6.17142	52	92	-3.34204	180	139	15.3786	649	186	49.5779	1493.5
46	-6.15103	53.8	93	-3.21584	184	140	16.2428	669.5	187	50.0111	1505.5
47	-6.12998	55.6	94	-3.08778	188	141	17.1518	691			

TABLE C-8 Type K (Nickel-Chromium vs. Nickel-Aluminum) thermocouple curve

Breakpoint	mV	Temp (K)	Breakpoint	mV	Temp (K)	Breakpoint	mV	Temp (K)
1	-9.834960	3.15	55	-8.713010	77.50	109	0.701295	285.0
2	-9.834220	3.59	56	-8.646710	80.00	110	1.061410	291.00
3	-9.833370	4.04	57	-8.578890	82.50	111	1.424820	297.00
4	-9.832260	4.56	58	-8.509590	85.00	112	1.791560	303.00
5	-9.830920	5.12	59	-8.438800	87.50	113	2.161610	309.00
6	-9.829330	5.72	60	-8.366570	90.00	114	2.534960	315.00
7	-9.827470	6.35	61	-8.292900	92.50	115	2.943070	321.50
8	-9.825370	7.00	62	-8.217810	95.00	116	3.355100	328.00
9	-9.822890	7.70	63	-8.141330	97.50	117	3.770870	334.50
10	-9.820010	8.45	64	-8.047780	100.50	118	4.190420	341.00
11	-9.816880	9.20	65	-7.952190	103.50	119	4.613650	347.50
12	-9.813290	10.00	66	-7.854690	106.50	120	5.040520	354.00
13	-9.809180	10.85	67	-7.755260	109.50	121	5.470960	360.50
14	-9.804510	11.75	68	-7.653960	112.50	122	5.938380	367.50
15	-9.799510	12.65	69	-7.550790	115.50	123	6.409870	374.50
16	-9.793900	13.60	70	-7.445790	118.50	124	6.885210	381.50
17	-9.787610	14.60	71	-7.338970	121.50	125	7.364360	388.50
18	-9.780590	15.65	72	-7.230370	124.50	126	7.881760	396.00
19	-9.773150	16.70	73	-7.120010	127.50	127	8.403380	403.50
20	-9.764910	17.80	74	-6.989110	131.00	128	8.928940	411.00
21	-9.755820	18.95	75	-6.855790	134.50	129	9.493760	419.00
22	-9.746230	20.10	76	-6.720200	138.00	130	10.0629	427.00
23	-9.735700	21.30	77	-6.582330	141.50	131	10.6361	435.00
24	-9.724650	22.50	78	-6.442220	145.00	132	11.2494	443.50
25	-9.713080	23.70	79	-6.299900	148.50	133	11.867	452.00
26	-9.699960	25.00	80	-6.155400	152.00	134	12.5253	461.00
27	-9.686220	26.30	81	-6.008740	155.50	135	13.188	470.00
28	-9.671890	27.60	82	-5.859960	159.00	136	13.892	479.50
29	-9.655790	29.00	83	-5.687430	163.00	137	14.6005	489.00
30	-9.638980	30.40	84	-5.512090	167.00	138	15.3507	499.00
31	-9.621500	31.80	85	-5.334130	171.00	139	16.1432	509.50
32	-9.602020	33.30	86	-5.153520	175.00	140	16.9403	520.00
33	-9.581740	34.80	87	-4.970330	179.00	141	17.7798	531.00
34	-9.560710	36.30	88	-4.784590	183.00	142	18.6624	542.50
35	-9.537440	37.90	89	-4.596330	187.00	143	19.5881	554.50
36	-9.513290	39.50	90	-4.405600	191.00	144	20.5573	567.00
37	-9.486720	41.20	91	-4.212440	195.00	145	21.5702	580.00
38	-9.457560	43.00	92	-3.992330	199.50	146	22.627	593.50
39	-9.427340	44.80	93	-3.769140	204.00	147	23.7279	607.50
40	-9.396080	46.60	94	-3.543070	208.50	148	24.873	622.00
41	-9.363810	48.40	95	-3.314120	213.00	149	26.0623	637.00
42	-9.330540	50.20	96	-3.082340	217.50	150	27.3356	653.00
43	-9.296270	52.00	97	-2.847790	222.00	151	28.6935	670.00
44	-9.257090	54.00	98	-2.610520	226.50	152	30.1761	688.50
45	-9.216690	56.00	99	-2.343820	231.50	153	31.8242	709.00
46	-9.175140	58.00	100	-2.073770	236.50	154	33.7187	732.50
47	-9.132450	60.00	101	-1.800570	241.50	155	36.1028	762.00
48	-9.088620	62.00	102	-1.524210	246.50	156	41.8502	833.00
49	-9.043710	64.00	103	-1.244740	251.50	157	44.2747	863.00
50	-8.997710	66.00	104	-0.962207	256.50	158	46.2907	888.00
51	-8.950650	68.00	105	-0.676647	261.50	159	48.1007	910.50
52	-8.902530	70.00	106	-0.359204	267.00	160	49.8256	932.00
53	-8.840980	72.50	107	-0.009079	273.00	161	51.5056	953.00
54	-8.777760	75.00	108	0.344505	279.00			

TABLE C-9 Type E (Nickel-Chromium vs. Copper-Nickel) Thermocouple Curve



Breakpoint	mV	Temp (K)	Breakpoint	mV	Temp (K)	Breakpoint	mV	Temp (K)
1	-6.257510	3.15	56	-5.424100	84.00	111	0.623032	289.00
2	-6.257060	3.56	57	-5.380600	86.50	112	0.843856	294.50
3	-6.256520	4.00	58	-5.336260	89.00	113	1.067190	300.00
4	-6.255810	4.50	59	-5.291080	91.50	114	1.293090	305.50
5	-6.254950	5.04	60	-5.245070	94.00	115	1.521570	311.00
6	-6.253920	5.62	61	-5.188800	97.00	116	1.752660	316.50
7	-6.252780	6.20	62	-5.131290	100.00	117	1.986340	322.00
8	-6.251380	6.85	63	-5.072630	103.00	118	2.222600	327.50
9	-6.249730	7.55	64	-5.012780	106.00	119	2.461410	333.00
10	-6.247810	8.30	65	-4.951770	109.00	120	2.702740	338.50
11	-6.245590	9.10	66	-4.889610	112.00	121	2.946550	344.00
12	-6.243040	9.95	67	-4.826300	115.00	122	3.192800	349.50
13	-6.240300	10.80	68	-4.761840	118.00	123	3.441440	355.00
14	-6.237210	11.70	69	-4.696250	121.00	124	3.715300	361.00
15	-6.233710	12.65	70	-4.629530	124.00	125	3.991980	367.00
16	-6.229800	13.65	71	-4.561670	127.00	126	4.271300	373.00
17	-6.225630	14.65	72	-4.492700	130.00	127	4.553250	379.00
18	-6.221000	15.70	73	-4.422610	133.00	128	4.837770	385.00
19	-6.215860	16.80	74	-4.351390	136.00	129	5.148790	391.50
20	-6.210430	17.90	75	-4.266950	139.50	130	5.462770	398.00
21	-6.204430	19.05	76	-4.180930	143.00	131	5.779560	404.50
22	-6.198680	20.10	77	-4.093440	146.50	132	6.099160	411.00
23	-6.191780	21.30	78	-4.004430	150.00	133	6.421500	417.50
24	-6.184530	22.50	79	-3.913940	153.50	134	6.746540	424.00
25	-6.176930	23.70	80	-3.821970	157.00	135	7.095510	431.00
26	-6.168310	25.00	81	-3.728520	160.50	136	7.455590	438.00
27	-6.159280	26.30	82	-3.633620	164.00	137	7.814630	445.00
28	-6.149830	27.60	83	-3.537260	167.50	138	8.176630	452.00
29	-6.139220	29.00	84	-3.439460	171.00	139	8.541540	459.00
30	-6.128130	30.40	85	-3.340240	174.50	140	8.909320	466.00
31	-6.116580	31.80	86	-3.239610	178.00	141	9.306450	473.50
32	-6.103700	33.30	87	-3.122930	182.00	142	9.706830	481.00
33	-6.090300	34.80	88	-3.004370	186.00	143	10.1103	488.50
34	-6.075460	36.40	89	-2.884040	190.00	144	10.5169	496.00
35	-6.060040	38.00	90	-2.761910	194.00	145	10.9264	503.50
36	-6.044070	39.60	91	-2.638010	198.00	146	11.3664	511.50
37	-6.025470	41.40	92	-2.512340	202.00	147	11.8098	519.50
38	-6.006200	43.20	93	-2.384920	206.00	148	12.2564	527.50
39	-5.986280	45.00	94	-2.255770	210.00	149	12.7342	536.00
40	-5.965730	46.80	95	-2.124900	214.00	150	13.2155	544.50
41	-5.942210	48.80	96	-1.992320	218.00	151	13.7	553.00
42	-5.917930	50.80	97	-1.858060	222.00	152	14.1879	561.50
43	-5.892970	52.80	98	-1.705090	226.50	153	14.7079	570.50
44	-5.864730	55.00	99	-1.549970	231.00	154	15.2314	579.50
45	-5.835680	57.20	100	-1.392820	235.50	155	15.7583	588.50
46	-5.805860	59.40	101	-1.233640	240.00	156	16.2887	597.50
47	-5.776670	61.50	102	-1.072450	244.50	157	16.8224	606.50
48	-5.741100	64.00	103	-0.909257	249.00	158	17.3594	615.50
49	-5.704560	66.50	104	-0.744065	253.50	159	17.9297	625.00
50	-5.667130	69.00	105	-0.576893	258.00	160	18.5037	634.50
51	-5.628800	71.50	106	-0.407776	262.50	161	19.1116	644.50
52	-5.589590	74.00	107	-0.217705	267.50	162	19.7538	655.00
53	-5.549510	76.50	108	-0.025325	272.50	163	20.4611	666.50
54	-5.508560	79.00	109	0.188573	278.00	164	20.8627	673.00
55	-5.466760	81.50	110	0.404639	283.50			

TABLE C-10 Type T (Copper vs. Copper-Nickel) thermocouple curve

Breakpoint	mV	Temp (K)	Breakpoint	mV	Temp (K)
1	-4.6667		32	-2.24537	160
2	-4.62838	6.35	33	-2.06041	170
3	-4.60347	8.15	34	-1.86182	180.5
4	-4.58043	9.75	35	-1.66004	191
5	-4.53965	12.5	36	-1.47556	200.5
6	-4.47226	16.95	37	-1.0904	220
7	-4.43743	19.3	38	-0.73397	237.5
8	-4.39529	22.2	39	-0.68333	240
9	-4.34147	26	40	-0.3517	256
10	-4.29859	29.1	41	-0.2385	261.5
11	-4.26887	31.3	42	0.078749	277
12	-4.22608	34.5	43	0.139668	280
13	-4.2018	36.3	44	0.426646	294.5
14	-4.02151	49.8	45	0.546628	300.5
15	-3.94549	55.4	46	0.858608	316
16	-3.87498	60.5	47	0.938667	320
17	-3.80464	65.5	48	1.3456	340
18	-3.73301	70.5	49	1.7279	358.5
19	-3.65274	76	50	1.76905	360.5
20	-3.5937	80	51	2.20705	381.5
21	-3.51113	85.5	52	2.51124	396
22	-3.45023	89.5	53	2.69878	405
23	-3.43451	90.5	54	2.94808	417
24	-3.37842	94	55	3.13562	426
25	-3.35469	95.5	56	3.43707	440.5
26	-3.28237	100	57	3.85513	460.5
27	-3.11919	110	58	4.17136	475.5
28	-2.95269	120	59	4.28662	481
29	-2.78168	130	60	4.64037	498
30	-2.60639	140	61	4.68168	500
31	-2.42737	150			

TABLE C-11 Chromel-AuFe 0.03% thermocouple curve

Breakpoint	mV	Temp (K)	Breakpoint	mV	Temp (K)	Breakpoint	mV	Temp (K)
1	-5.279520	3.15	35	-3.340820	115.00	69	1.313400	
2	-5.272030	3.78	36	-3.253410	119.50	70	1.511140	341.50
3	-5.263500	4.46	37	-3.165360	124.00	71	1.709250	350.50
4	-5.253730	5.20	38	-3.076690	128.50	72	1.928940	360.50
5	-5.242690	6.00	39	-2.977480	133.50	73	2.127070	369.50
6	-5.229730	6.90	40	-2.877550	138.50	74	2.324710	378.50
7	-5.214770	7.90	41	-2.776950	143.50	75	2.523070	387.50
8	-5.196980	9.05	42	-2.675700	148.50	76	2.643480	393.00
9	-5.176250	10.35	43	-2.563610	154.00	77	2.708890	396.00
10	-5.150910	11.90	44	-2.450770	159.50	78	2.764030	398.50
11	-5.116700	13.95	45	-2.337230	165.00	79	2.797580	400.00
12	-5.049770	17.90	46	-2.223010	170.50	80	2.950200	406.50
13	-5.002120	20.70	47	-2.097700	176.50	81	3.008310	409.00
14	-4.938000	24.50	48	-1.971630	182.50	82	3.031200	410.00
15	-4.876180	28.20	49	-1.844890	188.50	83	3.218040	418.00
16	-4.801670	32.70	50	-1.706840	195.00	84	3.300110	421.50
17	-4.648620	42.00	51	-1.568040	201.50	85	4.000810	451.50
18	-4.569170	46.80	52	-1.428520	208.00	86	4.246390	462.00
19	-4.499080	51.00	53	-1.277520	215.00	87	4.701810	481.50
20	-4.435090	54.80	54	-1.114900	222.50	88	4.947390	492.00
21	-4.370520	58.60	55	-0.940599	230.50	89	5.636410	521.50
22	-4.303610	62.50	56	-0.754604	239.00	90	5.870300	531.50
23	-4.234290	66.50	57	-0.556906	248.00	91	6.547630	560.50
24	-4.164270	70.50	58	-0.358437	257.00	92	6.711600	567.50
25	-4.093560	74.50	59	-0.170179	265.50	93	6.781410	570.50
26	-4.022170	78.50	60	0.041150	275.00	94	6.931500	577.00
27	-3.950100	82.50	61	0.152699	280.00	95	7.001360	580.00
28	-3.877360	86.50	62	0.163149	280.50	96	7.166710	587.00
29	-3.803960	90.50	63	0.374937	290.00	97	7.260420	591.00
30	-3.729910	94.50	64	0.542973	297.50	98	7.412010	597.50
31	-3.655230	98.50	65	0.598604	300.00	99	7.529070	602.50
32	-3.579930	102.50	66	0.774384	308.00	100	7.657460	608.00
33	-3.504020	106.50	67	0.840638	311.00	101	7.704410	610.00
34	-3.427530	110.50	68	1.126350	324.00			

TABLE C-12 Chromel-AuFe 0.07% thermocouple curve